



Guide to the Ex world

How to use the electrical equipment in areas with risk of explosion



To be sure to be safe.

Index

1. Introduction	pag. 5
2. Hazardous areas classification	pag. 13
3. Equipment choice	pag. 20
3.1. Groups, categories and EPL (Equipment Protection Level)	pag. 20
3.2. Protection methods	pag. 23
3.3. Electrical equipment	pag. 24
3.3.1. Gases	pag. 24
3.3.2. Dusts	pag. 25
3.4. Non-electrical equipment	pag. 25
3.5. "Ex" Abecedarium	pag. 27
3.6. Cortem Group equipment	pag. 27
3.6.1. Product classes	pag. 27
3.6.2. Our protection methods	pag. 30
3.6.2.1. "Ex d" explosion-proof junction boxes (literally flame-proof)	pag. 33
3.6.2.2. "Ex e" increased safety equipment	pag. 36
3.6.2.3. "Ex n" equipment	pag. 39
3.6.2.4. "Ex t" equipment	pag. 39
3.6.2.4.1. Enclosure protection degrees (IP code)	pag. 39
3.6.2.5. "Ex de" combined protection method	pag. 41
3.6.3. Marking of explosion-proof equipment	pag. 42
3.6.4. The ambient temperature of our equipment	pag. 48
3.6.5. Our temperature classes	pag. 49
3.6.6. Materials used in our equipment	pag. 49
3.6.6.1. Aluminium alloy	pag. 49
3.6.6.2. Stainless steel	pag. 50
3.6.6.3. Polyester reinforced with glass fibers	pag. 51
3.6.6.4. Borosilicate glass	pag. 52
3.6.6.5. Polycarbonate	pag. 53
3.6.6.6. Nickel-plated brass	pag. 53
3.6.6.7. Galvanized steel	pag. 53
3.6.6.8. Polyamide 6	pag. 53
3.6.6.9. Neoprene	pag. 54
3.6.6.10. Silicone	pag. 54
3.6.7. Our certifications (PART I)	pag. 54
3.6.7.1. The 2014/34/UE Directive	pag. 54
3.6.7.2. IEC-Ex	pag. 55
3.6.7.3. Russia	pag. 55
3.7. Our certifications (PART II)	pag. 58
3.7.1. The "UE conformity statement"	pag. 58
3.7.2. "User instructions"	pag. 59
4. Installation	pag. 60

Index

5. Inspection	pag. 63
6. Maintenance and repairs	pag. 65
6.1. Maintenance	pag. 65
6.2. Repairs	pag. 66
7. End-of-life equipment	pag. 67
7.1. Disposal	pag. 67
7.2. Recyclability	pag. 68
8. Application examples for different types of plants	pag. 69
8.1. Pharmaceutical industries	pag. 69
8.1.1. Reference standards	pag. 70
8.1.2. Plant emission sources	pag. 70
8.1.3. Classification for gas	pag. 71
8.1.4. Classification for dusts	pag. 71
8.2. Deposit of cereals	pag. 71
8.2.1. Risk of explosion by clouds of dust	pag. 72
8.2.2. Areas classification	pag. 72
8.2.3. Areas inside containment system	pag. 72
8.2.4. Areas outside containment system	pag. 72
8.2.5. Electrical installations	pag. 73
8.3. Coating booths	pag. 73
8.3.1. Coating booths with liquid coatings	pag. 73
8.3.2. Coating booths with dust coatings	pag. 74
8.4. Biogas plants	pag. 75
8.4.1. Plant type	pag. 75
8.4.2. Risk of explosion	pag. 76
8.4.3. Regulations	pag. 76
9. Appendix	pag. 77
9.1. Brief description of protection methods for electrical equipment addressed to areas with risk of explosion for presence of gas	pag. 77
9.2. Brief description of protection methods for electrical equipment addressed to areas with risk of explosion for presence of dusts	pag. 78
9.3. Brief description of protection methods for non-electrical equipment addressed to areas with risk of explosion due to presence of gas and dusts	pag. 78
Marking of electrical equipment in areas with risk of explosion	pag. 79

1. Introduction



During production, transformation, delivery and stocking of flammable substances in the chemical and petrochemical plants, so as during the production of oil and natural gas, inside the mines and in many other fields (such as the food field), gases, vapors and mists are produced. In contact with the oxygen in the air, they can create an explosive atmosphere. If this atmosphere is triggered, the deriving explosion can provoke serious damages to people and environment.

The aim of this Guide is to follow the Ex path (Image 1, following page), providing experts and non with an overview on the world of the explosion-proof electrical protection.

It is worth remembering that inside the European Community, there are the technical standards (to be applied to reduce risks), and the Community guidelines which are prevalent on technical standards. The European law has intervened to discipline different fields; for our memo we will consider two blocks:

- the Product Directives;
- the Social Directives.

The *Product Directives* were born in the first half of the 80s in or-

1.Introduction

Image 1 Ex path

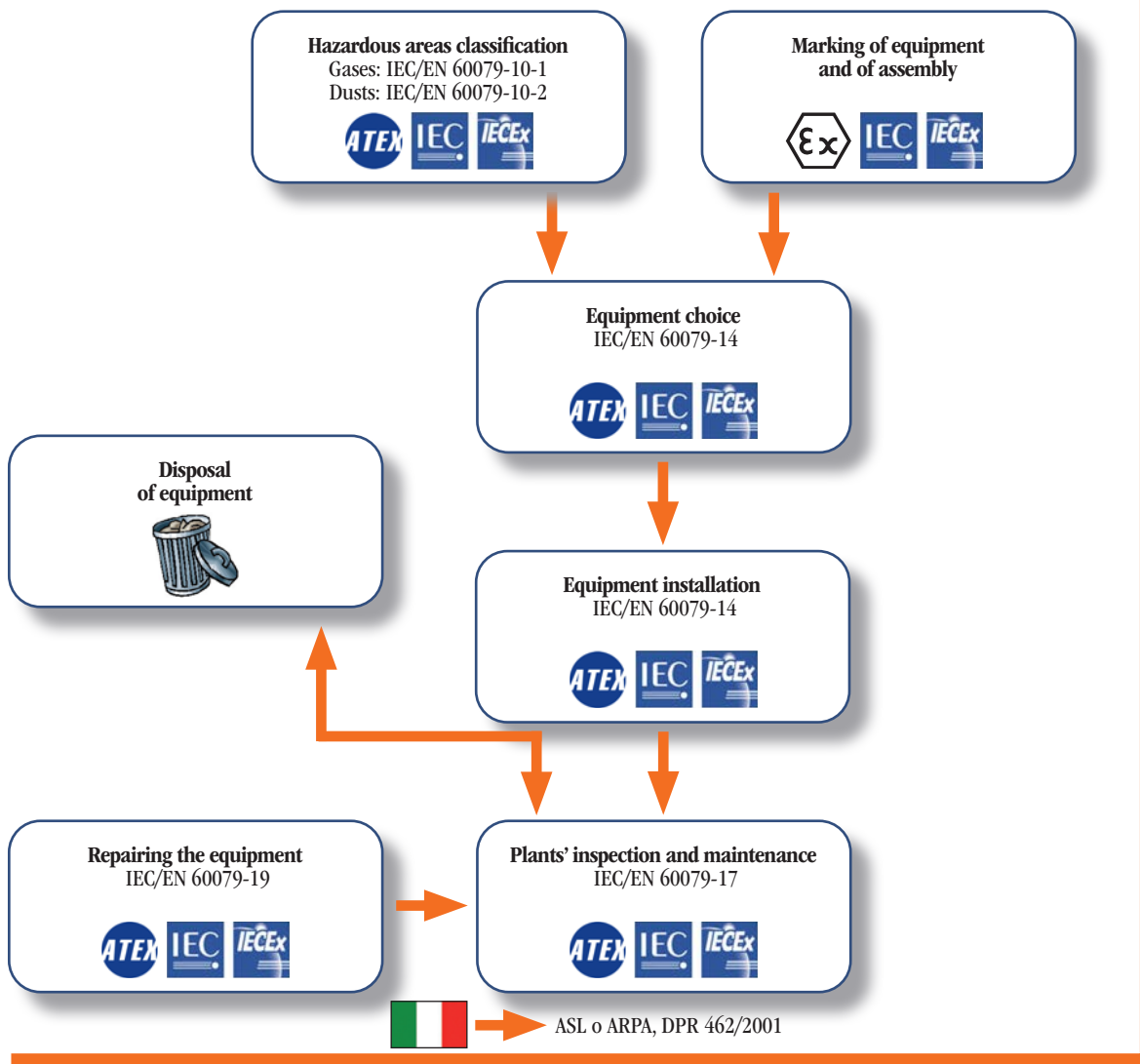

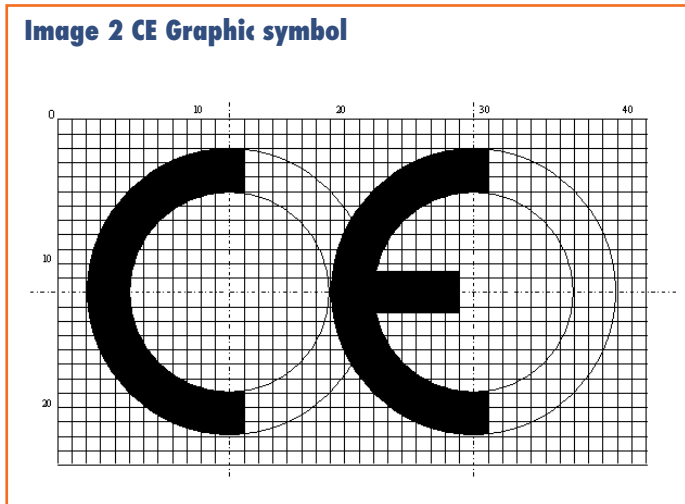

der to eliminate national laws and unify the technical references on the various products. With an unique European reference and the passage from national to European harmonized standards, national barriers were eliminated and the goods could freely circulate within the Community, as stated in the article No. 100 (now article No. 95) of the Treaty signed in Rome in March 1957, where the Economic European Community was founded. This path, composed of the first legislative documents (Directives, Decisions, Resolutions) became complete in the first half of the 90s, with the decision that the products fulfilling the Safety and Health Essential Requirements defined in the related Directive, had to bear a graphic mark to circulate freely within the European Community. This graphic mark is the CE

Image 2 CE Graphic symbol



Tab. 1 83/189/CEE "Framework Directive": enactment, amendments and implementation in Italy

"Framework Directive" http://ec.europa.eu/enterprise/policies		
	83/189/CEE Directive by the Commission of 28th March 1983 concerning the "information procedure in the field of technical standards and regulations"	Law 21st June 1986, n° 317, concerning the "application of the directive n° 83/189/CEE about the information procedure in the field of technical and standards and regulations"
	(G.U.C.E., L series, n° 109 of 26 April 1983)	(G.U.R.I., General series, n° 151 of 2 July 1986)
	modified by: decision n° 768/2008/CE of the European Parliament and the Council of 9 July 2008 concerning a common frame for the product trading and that repeals 93/465/CEE decision.	
G.U.U.E. of 13th August 2008 (L 218/82/IT)		

(Image 2) that has to comply with certain proportions.

Over the years, the first legislative documents have been emended, integrated and modified till the last revision, dated 2008 (Table 1).

In this block, along with many other Product Directives (low voltage, electromagnetic compatibility, equipment, etc.) there is the Directive 2014/34/UE (by virtue of the article of the Treaty)

It is addressed to manufacturers of equipment that will be used in potentially explosive atmosphere. These manufacturers, after

Tab. 2 "ATEX" Directive: enactment and implementation in Italy

		
"ATEX"	DIRECTIVE 2014/34/UE OF THE EUROPEAN PARLIAMENT AND THE COUNCIL of 26th February 2014 on the "approximation of the laws of the Member States concerning equipment and protective systems intended for use in potentially explosive atmosphere" (recast)	LAW of 9th July 2015, n. 114 Mandate to the Government for the transposition of european directives and the implementation of other acts of European Union - Law of european delegation 2014. (15G00127) In force on:
	(G.U.U.E. n° L 96 of 29th March 2014)	(G.U.R.I. n° 176 of 31st July 2015)

the conformity assessment procedure foreseen for the equipment group and category, will put, in addition to the CE mark, also the graphic symbol of the "ATEX" Directive (Table 2).

Its official name is "distinctive community mark". The hexagon inscribed with the epsilon-x must have the proportions as indicate in Image 3.

The *Social Directives* were born in the second half of the 80s to implement measures to improve the workers' health and safety at work by the achievement of an harmonization of the workers' protection levels in the EU, and by defining the minimum requirements to improve working environment, such as to protect the workers' safety, as it was stated, in the article 118 (now article 137) of the Treaty signed in Rome in March 1957, in which the Economic European Community was founded (Tables 3 and 4).



Over the years, the "framework" Directive has been integrated with "specific" Directives that took into consideration the various

risks existing in the working environment (construction sites, extracting industries, physical agents, etc.) and, consequently, there have been the various national transpositions among those the last one, at Italian level, is the one that generated the "Consolidated law on health and safety at work, with the legislative Decree of 9th April 2008, No. 81, published on G.U.R.I No. 101 of 30th April 2008

Image 3 European Community mark



Tab. 3 89/391/CEE "Framework Directive": promulgation and implementation in Italy

"Framework Directory" http://ec.europa.eu/social		
	Council Directive 89/391/EEC of 12 June 1989 on the introduction of measures to encourage improvements in the safety and health of workers at work (G.U.C.E., L series, n° 183 of 29 June 1989)	Leg. September 19, 1994, No. 626, concerning the "implementation of Directives 89/391/EEC, 89/654 / EEC, 89/655/EEC, 89/656/EEC, 90/269/EEC, 90 / 270/CEE, 90/394/EEC, 90/679/EEC, 93/88 / EEC, 95/63/EC, 97/42/EC, 98/24/EC, 99/38/EC, 99/92 / EC, 2001/45/EC, 2003/10/EC, 2003/18/EC and 2004/40/EC concerning the improvement of safety and health of workers at work " (G.U.R.I., General series, n° 265 of 12 November 1994)



and later update with the legislative Decree of 14th September 2015, No. 151 and published on G.U.R.I No. 221 of 23rd September 2015, such as measures to rationalise and simplify procedures and compliances at the expense of citizen and companies, and other measures about work relation and equal opportunities, as implementation of the law of 10th December 2014, No. 183.

In this block, there is the 1999/92/CE Directive, known as "ATEX 137" (by virtue of the article number in the Treaty) or more simply as the second "ATEX" Directive.

It is addressed to the employers of the workers who can be exposed to the risk of explosive atmospheres.

Now, the collection of these two blocks of Directives, the

Tab. 4 "ATEX 137" Directive: promulgation and implementation in Italy

 "ATEX 137" http://ec.europa.eu/social		
	Directive 1999/92/EC of the European Parliament and of the Council of 16 December 1999 "minimum requirements for improving the safety and health protection of workers potentially at risk from explosive atmospheres" (XV individual Directive within the meaning of Article 16, paragraph 1 of Directive 89/391/EEC) (G.U.C.E., L series, n° 23 of 28 January 2000)	Leg. June 12, 2003, No. 233 "Implementation of Directive 1999/92/EC on minimum requirements for improving the safety and health protection of workers potentially at risk from explosive atmospheres" (G.U.R.I., General series, n° 197 of 26 August 2003)

Graph 1 Number of fatal and non-fatal accidents at workplace during 2018 inside European Union

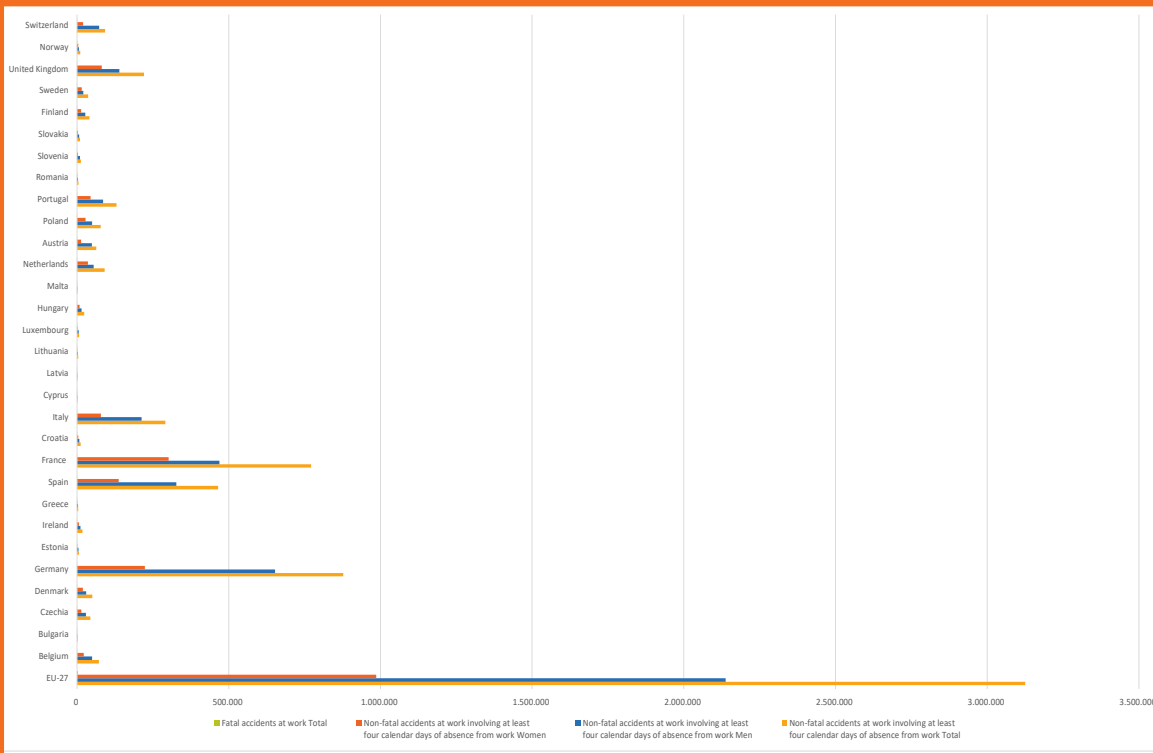

Note: non-fatal accidents reported in the framework of ESAW are accidents that imply at least four full calendar days of absence from work (serious accidents).

Source: Eurostat - online data codes: hsw_n2_01 and hsw_n2_02 ESAW (European Statistics on Accidents at Work)

equipment or, more generally, the “products” put on the market regardless of their use (domestic or industrial) from one side, and the health and safety at work from the other, make that, each of them, with its own role, contributes to a general improvement of working conditions.

Even though we keep on giving ourselves news rules increasing the “state of the art” and we turn to the best and the most independent of the Notified Bodies for our product certification, there will always be some risks.

But what is the risk?

It is difficult to gather information but, to have an idea, we can have a look at the graphs 1, 2 and 3, taken from Eurostat “European statistics on accidents at work” (ESAW) (data processed in November 2020). The first graph represents non-fatal and fatal accidents at work in the countries of the European Union, the second by type of accident and the third the evolution of fatal accidents at work for the five sections of NACE with the highest risk levels from

Notes: EU_V indicates that, for this analysis, 20 Member States (out of 27) have provided the information. Two points reported in Graphs 1 and 2 indicate that the information is not available or that it comprises less than 4 elements.

Graph 2 Fatal and non-fatal accidents at work by type of injury, EU-27, 2018

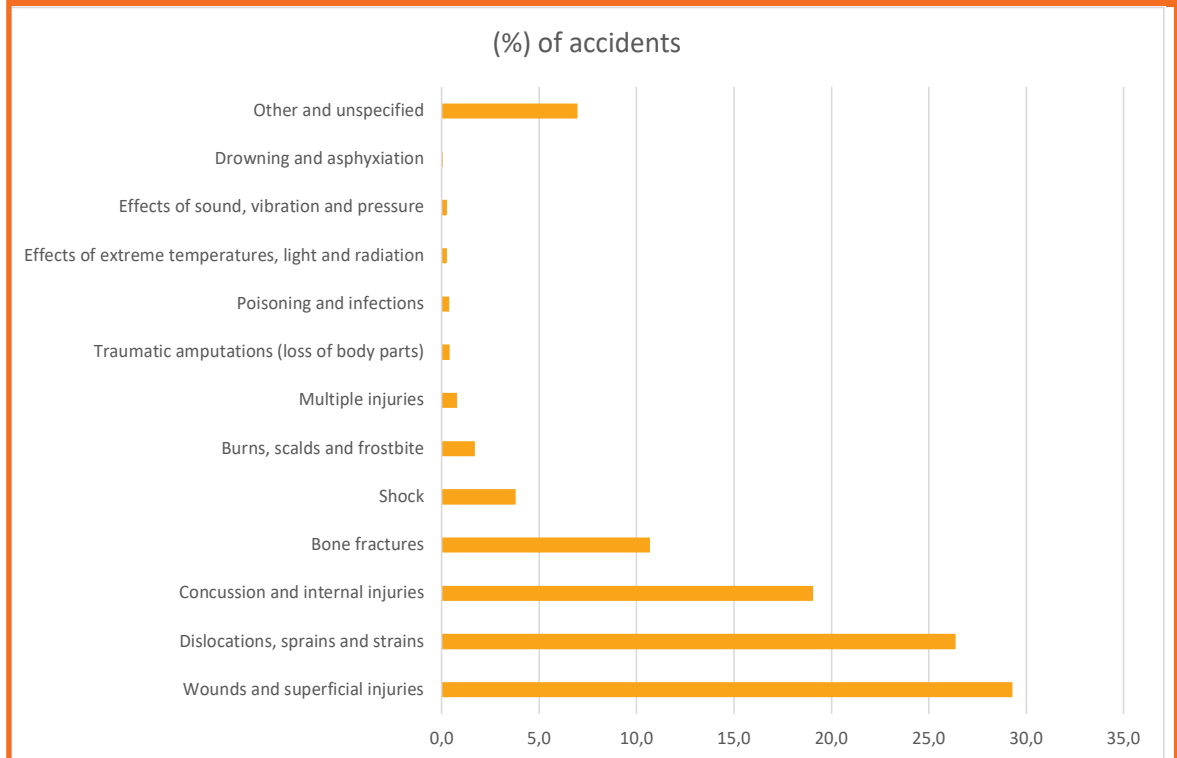

Eurostat - online data code: hsw_n2_07 ESAW (European Statistics on Accidents at Work)

2010 to 2018.

As you can see, in all five sections of NACE there has been a decreasing trend in accidents thanks to the rules we have set ourselves and the “risk analysis” tool that considers whether the potential ignition sources are present or not and, if present, what they are worth and what effects they can produce in case of contact with a potentially explosive mixture inside its explosive ranges.

The sources to take into consideration are:

- hot surfaces; ⚠
- flames and hot gases (hot particles included);
- mechanically generated sparks;
- electrical equipment; ⚠
- stray electrical currents, cathodic corrosion protection;
- static electricity;
- lightning;
- electromagnetic waves; ⚠
- ionizing radiations; ⚠

1.Introduction

Graph 3 Development of fatal accidents at work for the five NACE sections with the highest risk levels, EU-27, 2010-2018 (persons)

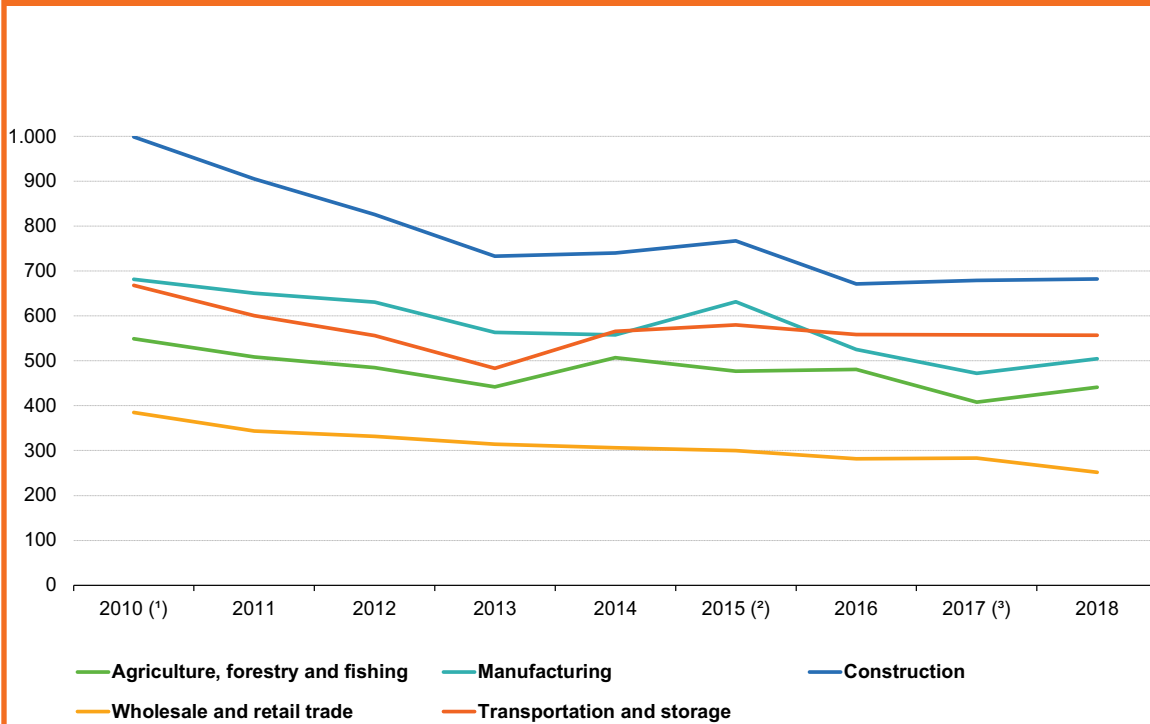

(¹) Estimates, except for agriculture, forestry and fishing and manufacturing.

(²) Agriculture, forestry and fishing and wholesale and retail trade: low reliability. Manufacturing, construction and transportation and storage: estimates.

(³) Low reliability.

Source: Eurostat (online data code: hsw_n2_07) ESAW (European Statistics on Accidents at Work)

- ultrasound;
- adiabatic compression and shock waves;
- exothermic relations, self-ignition of dust included.

To have an explosion it is not sufficient that fuel, oxidizer and ignition meet (Image 4), but, in addition to this, there must be the confinement in which the combustion occurs (Image 5). ■

Image 4 The fire triangle

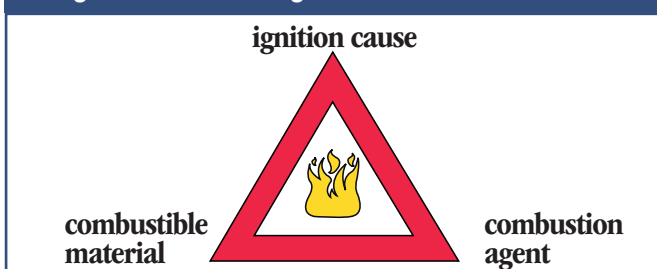
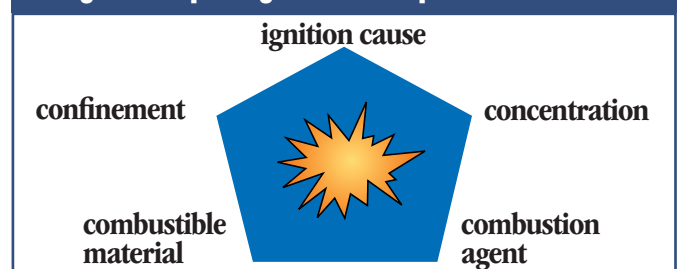

Image 5 The pentagon of the explosion



2. Hazardous areas classification



In facing the chapter on the classification, the first thing that came to our minds is: *what is classification?*

The answers could be various: it is a document, it is the drawing with the “clouds”, it is a number identifying the area, it is the probability that the explosive atmosphere is present in a certain area.

The answers are correct, but only if considered all together.

We could therefore define the areas classification as a method of *analysis and classification of the environment where explosive atmospheres may occur because of the presence of gases and/or combustible dusts, in order to facilitate the correct choice and installation of the equipment to be used safely in that environment.*

It has to be pointed out that the references of the “state of the art”(technical standards) in this field (currently IEC 60079-10-1 for gases and IEC 60079-10-2 for combustible dusts) do not refer either to the areas with presence of fire-damp gas (group I), or to the areas where the explosives are processed and produced, etc.

The classification is a teamwork! The area classification should be made by people who understand the importance and meaning of the properties of flammable substances, as well as by people who are familiar with the process and the equipment, together with qualified personnel in the field of safety, electrical and mechanical installations, and more; it is necessary, moreover, a tight cooperation among experts in safety and equipment.

What are these areas?

More than we can imagine! The combustible gases classified in the regulation IEC 60079-20-1 are 328, while the combustible dusts listed in the BIA report 13/97 are more than 4.300, sawdust, flour and breadcrumbs included! And, since 1997, many others have been classified!

Reasoning by macro areas, the classification could be required for the following areas:



Some of these hazardous areas will be analyzed in chapter 8.

What do we have to do?

First of all we have to build the team!

After that, step by step, work must be faced.

a) Identifying the hazardous substances – with the help of the information contained in the safety form, in the IEC 60079-20-1 standard “Explosive atmospheres – part 20-1: classification of gases and vapors – test methods and information” in the BIA report 13/97 “Combustion and explosion – characteristics of dusts” and in the bibliographical references. But sometimes, especially for combustible dusts, the information we find in literature does not coincide with the characteristics of our sample (type of substance and grain size) or we are not in presence of a single dust. In these cases, it is recommended to refer to specialized centers in order to have the specimen characterization made; in Italy, a reference is the “Fuel Experimental Station” (<http://www.ssc.it>) based in San Donato Milanese (MI).

Some information about gas is interesting. In Table 5, we have gathered the gases that, for some reason, are representative of something:

- those highlighted in bold (No. 18, 20, 21, 27 and 288) are representative of the gas subgroups;
- No. 55 and 7 for the lower explosive limit (L.E.L), the lowest and the highest, respectively;
- No. 181 and 21, 37, 170, 293 for the

2. Hazardous areas classification

Tab. 5 Some of the most representative gases

	n° GAS	Name	Formula	L.E.L. [vol %]	U.E.L.	M.I.T. [°C]	M.I.E.* [μJ]	GROUP
7	64-18-6	Formic acid	HCOOH	18,00	57,00	525		IIA
18	74-82-8	methane	CH ₄	4,40	17,00	600	280	IIA
		firedamp gas		4,40	17,00	595		I
20	74-85-1	ethylene	CH ₂ =CH ₂	2,30	36,00	440	82	IIB
21	74-86-2	ethyne (acetylene)	CH=CH	2,30	100,00	305	19	IIC
27	74-98-6	propane	CH ₃ CH ₂ CH ₃	1,70	10,90	450	250	IIA
35	75-15-0	Carbon disulphide	CS ₂	0,60	60,00	90	9	IIC
37	75-21-8	ethylene oxide	CH ₂ CH ₂ O	2,60	100,00	429		IIB
55	78-10-4	tetraethoxysilane (silicic acid tetraethyl ester)	(C ₂ H ₅) ₄ Si	0,45	7,20	174		
170	110-05-4	bis (1.1-dimethylethyl) peroxide	(CH ₃) ₃ COOC(CH ₃) ₃	0,74	100,00	170		IIB
181	110-96-3	2-methyl-N-(2-methylpropyl)-1-propanammina (diisobutilammina)	((CH ₃) ₂ CHCH ₂) ₂ NH	0,80	3,60	256		IIA
206	123-42-2	4- hydroxy -4-methylpentane-2-one (diacetonolcol)	CH ₃ COCH ₂ C(CH ₃) ₂ OH	1,80	6,90	680		IIA
288	1333-74-0	hydrogen	H ₂	4,00	77,00	560	16	IIC
293	1712-64-7	nitric acid 1-methylethyl ester	(CH ₃) ₂ CHONO	2,00	100,00	175		IIB

Legenda: L.E.L.: (Lower Explosive Limit; U.E.L.: Upper Explosive Limit; M.I.T.: Minimum Ignition Temperature; M.I.E.: minimum Ignition Energy;

- upper explosive limit (U.E.L.), the lowest and the highest, respectively;
- No. 181 and 170 for the explosive limit, the least and the most extended, respec-

- tively;
- No. 35 and 206 for the ignition temperature, the minimum and the maximum, respectively.



Graph 4
Subdivision of gas in groups

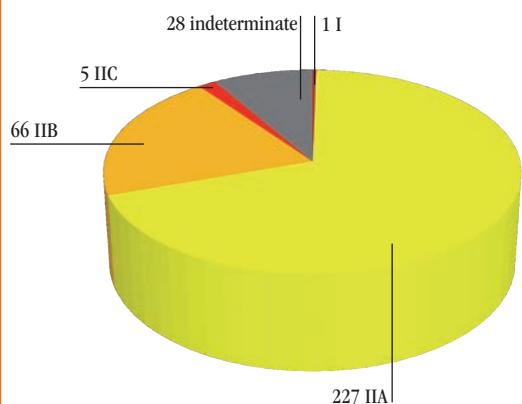

Graph 5
Number of gas for temperature class

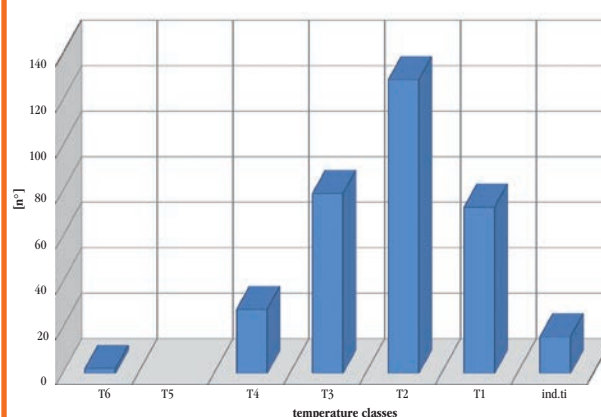

Tab. 6 Some of the most representative dusts

Combustible materials	Grain [µm]	Explosive level L.E.L. [g/m ³]	M.I.T. [°C]		M.I.E. [mJ]	K _{st} [°C]
			in cloud T _d	in 5 mm layer T _{5mm}		
wood	70	40	440	325	20	128
wheat flour	57	60	430	450	50	87
lactose	23	125	450	melts	10	81
rice	45	60	490	"	80	101
sugar	35	200	350	490	30	138
polyethylene	< 10	25	450	"	80	156
phenol	< 10	25	460	melts	10	129
aluminium	29	40	700	320	50	415
magnesium	28	30	600	490	120	508
zinc	< 10	480	680	460	650	176
coke	15	80	"	"	80	47
urea hydrolysed	13	70	450	"	80	136
cellulose	112	30	350	465	"	112

Legenda: L.E.L.: (Lower Explosive Limit; U.E.L.: Upper Explosive Limit;
M.I.T.: Minimum Ignition Temperature; M.I.E.: minimum Ignition Energy;

source: BIA-Report 13/97

2. Hazardous areas classification





In the Graph 4, the great prevalence of subgroup IIA is evident, while the Graph 5 shows the gas distribution in the temperature class identification with a Gaussian distribution.

As far as the dusts are concerned, being them almost unknown, the information is more complex to extract. Once identified the nature of dust, the second fundamental information for its identification is the average particle size. Let's have a look at some examples of dusts in Table 6 at the previous page. The information in the second column of

Table 6 depends on that in the first two columns. Here we have something different if compared to how we were used to treat gases: the dust ignition temperatures are characterized by two different state conditions: they may be triggered when, because of the convection, they move in the air forming "clouds" (T_{cl}), or when they are deposited on the surfaces forming increasingly thicker layers; conventionally we take as reference a layer of 5 mm (T_{5mm}).

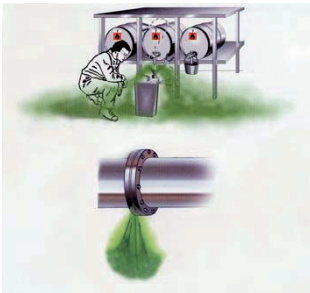
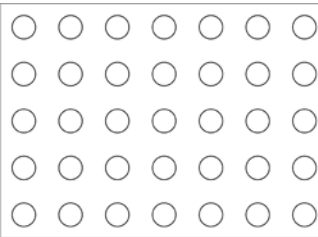
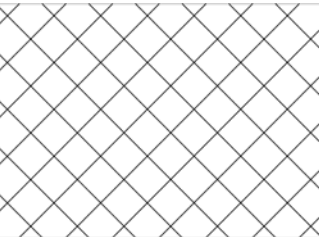
Moreover, we have to add that recently, as a technical standard, dusts have been classi-

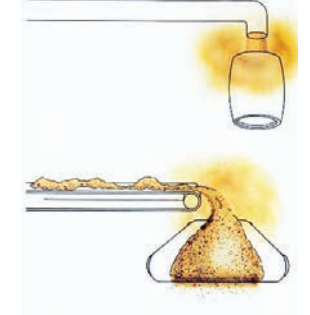
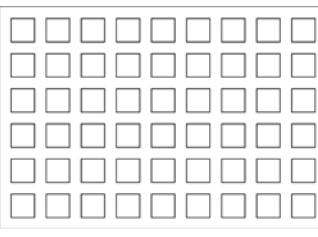
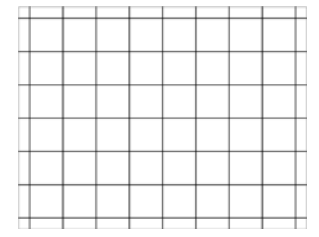
Image 6 Hazardous areas classification based on presence and concentration of gas (Zone 0, 1 and 2) and dusts (Zone 20, 21 and 22)

	Zone 0	Zone 1	Zone 2
			
	Zone 20	Zone 21	Zone 22
			

Note: the graphic images in the boxes are those normalized at international level



fied into three subcategories, similarly way to what was done years ago for gases. The subgroups are:

- IIIA: flammable particles, such as “solid particles, fibers included, with nominal sizes > 500 μm”;
- IIIB: non-conductive dust, such as “finely divided solid particles, with nominal sizes ≤ 500 μm, with electrical resistivity > 10³ Ωm”;
- IIIC: conductive dust, such as “finely divided solid particles, with nominal sizes ≤ 500 μm, with electrical resistivity ≤ 10³ Ωm”.

b) Identifying the emission sources – (continuous, first degree, second degree).

c) Defining the emission rate of the sources – (speed, geometry, concentration, volatility, temperature).





d) Establishing the ventilation degree.

e) Defining the hazardous areas (Image 6).

f) Defining the hazardous areas extension.

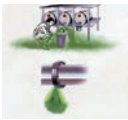



The areas division reported in Image 6 in the previous page is a widely spread system, in fact it is the one adopted both by Europe and by the international IEC standards. In case this division is not enough, UNECE, an UNO Agency, has reinforced this concept, and also in its latest report of 2011 (<http://www.enece.org/>) it refers to the international IEC standards as reference to adopt.

Tab. 7 Comparison between hazardous areas classification for presence of gas based on international standards (IEC Zone System) and according to North American standards

 GAS				
 	Zone 0	Area in which an explosive atmosphere, consisting in a mixture of air and flammable substances in the shape of gas, vapor or mist, is present permanently or for long periods or often.	Zone 1	Area in which during normal activities the formation of an explosive atmosphere consisting in a mixture of air and flammable substances in the shape of gas, vapor or mist, is possible.
				Class I, Division 1
	Zone 2		Area in which during normal activities the formation of an explosive atmosphere consisting in a mixture of air and flammable substances in the shape of gas, vapor or mist, is not possible, and in case it happens, it lasts very shortly.	Zone 2
		NEC 500	Class I, Zone 0	
NEC 505	Class I, Zone 0		Class I, Zone 1	Class I, Zone 2

2. Hazardous areas classification

Tab. 8 Comparison between hazardous areas classification for presence of dusts based on international standards (IEC Zone System) and according to North-American standards

 DUSTS				
 	Zone 20	Area in which an explosive atmosphere is present permanently or for long periods or often, in the shape of clouds of dusts.	Zone 21	Area in which occasionally during normal activities the formation of an explosive atmosphere in the shape of cloud of combustible dust in the air, is possible.
	Zone 22	Area in which during normal activities the formation of an explosive atmosphere in the shape of cloud of combustible dust is not possible, and in case it happens, it lasts very shortly.		
	NEC 500	Class II, Division 1		Class II, Division 2- Class III
	NEC 505	Class II, Zone 20	Class II, Zone 21	Class II, Zone 22

It can happen, however, that some documents written according to the North-American standards (USA and Canada) refer to their national standards and that, therefore, also the nomenclature is different from that adopted internationally. Tables 7 and 8 highlight the correlation between the two systems.

Regardless of the normative reference used, the hazardous areas classification will be composed of: a descriptive document, in which the factory, the processes taken into account, the list of the hazardous substances present, etc., will be identified; a plan drawing and a perspective drawing in which, by means of the proper conventional graphic symbols, the

limits of the “clouds” will be traced, that is to say of the extension of each classified area. This document, as it will be understood, is very important for the employer, who, on the basis of which, will have to make some choices and take some measures. Some information, necessary for the production process, has to be found in this document:

- installation area or category / EPL of the equipment that will have to be installed;
- gas subgroup or specific gas/es and/or dust subgroup or specific dust/s;
- max permissible temperature class of the equipment that will have to be installed;
- ambient temperature. ■

3. Equipment choice



3.1. Groups, categories and EPL (Equipment Protection Level)

The 2014/34/UE Directive is applied to the following products:

- a) equipment and protection systems addressed to the use in potentially explosive atmosphere;
- b) safety and control equipment addressed to the use outside potentially explosive atmosphere but necessary or useful to the safe operation of equipment and protection systems from explosion risk;
- c) components addressed to insertion inside equipment and protection systems aforementioned by the a) letter.

The 2014/34/UE Directive is not applied to

the following products:

- a) medical equipment addressed to medical use;
- b) equipment and protection systems, when the danger of explosion is due to the presence of explosive substances or chemical volatile ones;
- c) equipment for domestic and non-commercial use, in which a potentially explosive atmosphere could be caused only rarely and due to an accidental leak of gas;
- d) equipment for individual protection, subject of 89/686/CEE Directive of the Council, of 21st December 1989, regarding the reconciliation between legislations about personal protective equipment of the Member States (1);



e) ships and offshore mobile units, as well as the equipment used on board of those ships or units;

f) vehicles and their trailers exclusively addressed to the transport of people by air, or road/railway/navigation network; and vehicles for the transport of goods by air or by public road/railway/navigation network. The vehicles addressed to the use in potentially explosive atmosphere are not excluded by the application of this Directive;

g) the products considered in the No. 346 article, paragraph 1, b) letter of the treaty on European Union's role.

Parameters to classify groups of equipment in categories

1) Group I

Products addressed to mines and in their surface systems, where firedamp gas can be present.

There are two categories inside Group I, M1 and M2.

Category M1

Includes equipment designed and equipped with special protection devices to operate according to the operative parameters established by the manufacturer and to ensure a very high protection level.

- Equipment of this category is addressed to underground works in mines and in their surface plants exposed to the risk of firedamp gas and/or combustible dusts release.
- Equipment of this category must stay operative in explosive atmosphere, even in

case of exceptional damage. It is characterized by protection devices such that:

- if one of the two protection devices is damaged, at least a second independent one ensures the required protection level;
- if two damages occur, independent by each other, the required protection level is ensured.

Category M2

Include the equipment designed to operate according to the operative parameters established by the manufacturer and based on high protection level.

- Equipment of this category is addressed to underground works in mines and in their surface plants exposed to the risk of firedamp and/or combustible dusts release.
- In potentially explosive atmosphere, the power source of this equipment must stop.
- Protection devices of this category of equipment ensure the required protection level during the normal operation, even in difficult conditions, in particular when stress and continuous environmental changes occur.

2) Group II

This group includes equipment designed to operate according to operative parameters established by manufacturer and to ensure a very high protection level.

Inside Group II, there are three categories, 1, 2 and 3.

Category 1 (explosive atmosphere is always present or for long periods)

3. Equipment choice

Includes equipment designed to operate according to operative parameters established by the manufacturer and to ensure a very high protection level.

- Equipment of this category is addressed for environments where an explosive atmosphere occurs always, often or for long periods, due to mixtures of air and gases, vapors, fog or mixtures of air and dusts.
- Equipment of this category must stay operative in explosive atmosphere, even in case of exceptional damage. It is characterized by protection devices such that:
 - if one of the two protection devices is damaged, at least a second independent one ensures the protection level required;
 - or if two damages occur, independent by each other, the required protection level is ensured.

Category 2 (the development of explosive atmosphere is most likely)

Includes equipment designed to operate according to operative parameters established by the manufacturer and to ensure a high protection level.

- Equipment of this category is addressed for environments where explosive atmosphere may occur due to gases, vapors, fog or mixtures of air and dusts.
- Protection devices of this category of equipment ensure the required protection level also if there are recurring anomalies or bugs on the equipment that must be maintained.

Category 3 (development of explosive atmosphere is slightly possible)

Includes equipment designed to operate according to operative parameters established by the manufacturer and to ensure a normal protection level.

- Equipment of this category is addressed for environments where it is slightly possible, or only for short periods, that explosive atmosphere occurs due to gases, vapors, fog or mixtures of air and dusts.
- Equipment of this category ensures the required protection level during the normal operation.

3) Group III (see also the Table 6)

Equipment of Group III is addressed to the use in places with explosive atmosphere due to the presence of combustible dust different from mining with possible presence of fire-damp.

Inside Group III there are three categories:

- IIIA: combustible particles
- IIIB: no conductive dust
- IIIC: conductive dust

The category numbers of group II (1, 2, 3) are followed by a capital letter:

- G, for gases;
- D, for combustible dusts.

For example: II 2G.

On the basis of group II definitions and by comparing them to those provided by the 99/92/CE "ATEX 137" Directive, a two-way link is established and highlighted in Table 9, between equipment category and installation area.

Tab. 9 Correlation between equipment category and installation area for Group II

	1	2	3
G	Zone 0	Zone 1	Zone 2
D	Zone 20	Zone 21	Zone 22

What we have described above is valid for the EU.

Outside EU, until 2007, the equipment was marked only with the protection method. Therefore, inspired by the European system, the EPL Equipment Protection Level (Table 10) has been created, replacing the letters “a”, “b”, “c” to the numbers “1”, “2” and “3”.

Tab. 10 Correlation between equipment category and the protection level

	M1	M2	1G	2G	3G
EU			1D	2D	3D
World	Ma	Mb	Ga	Gb	Gc
			Da	Db	Dc

3.2. PROTECTION METHODS

The protection methods are techniques available thanks to the harmonized standards, aiming to meet the Safety and Health Essential Requirements.

These techniques “play” on the fact that, removing also only one of the elements which form the explosion Pentagon, the

Tab. 11 Standardization bodies subdivided according to technical competence and territoriality

	Field		
	Electrotechnical and electronic	International	International
International	Electrotechnical Commission Commission Electrotechnique International Geneve, Switzerland http://www.iec.ch	International Telecommunication Union Geneve, Switzerland http://www.itu.int	International Organization for Standardization Organisation internationale de normalisation Geneve, Switzerland http://www.iso.org/iso/home.htm
European	European Committee for Electrotechnical Standardization Comité Européen de Normalisation Electrotechnique Brussels, Belgium http://www.cenelec.eu	European Telecommunications Standards Institute Sophia Antipolis, France http://www.etsi.org	European Committee for Standardization Comité européen de normalisation Brussels, Belgium http://www.cen.eu
Italy	Italian Electrotechnical Committee Milan, Italy http://www.ceiweb.it	CONCIT National Coordinating Committee for Informatics and telecommunications Rome, Italy http://www.isticom.it	Italian National body of unification Milan, Italy http://www.uni.com

3. Equipment choice

explosion itself cannot take place. So, by limiting the energy (**intrinsic safety**) and the heat (**increased safety, structural safety**), by removing the fuel (**pressurization, liquid immersion, encapsulation**), by containing the explosion (**flame-proof junction boxes**), the purpose is achieved.

Regularly, the European Commission publishes in the Official Journal of the European Union the list of the harmonized technical

standards which tend to comply with the requirements of the ATEX Directive.

The standardization bodies are divided according to their technical competence and territoriality, as it is represented in Table 11 in the previous page.

In the Graphs 6, 7 and 8 we quote the main protection methods for electrical and non-electrical equipment. For a deep analysis of the protection methods that Cortem uses, refer to paragraph 3.6.2.

3.3. ELECTRICAL EQUIPMENT

3.3.1. GASES

Graph 6 Main protection modes for electrical equipment in presence of gas

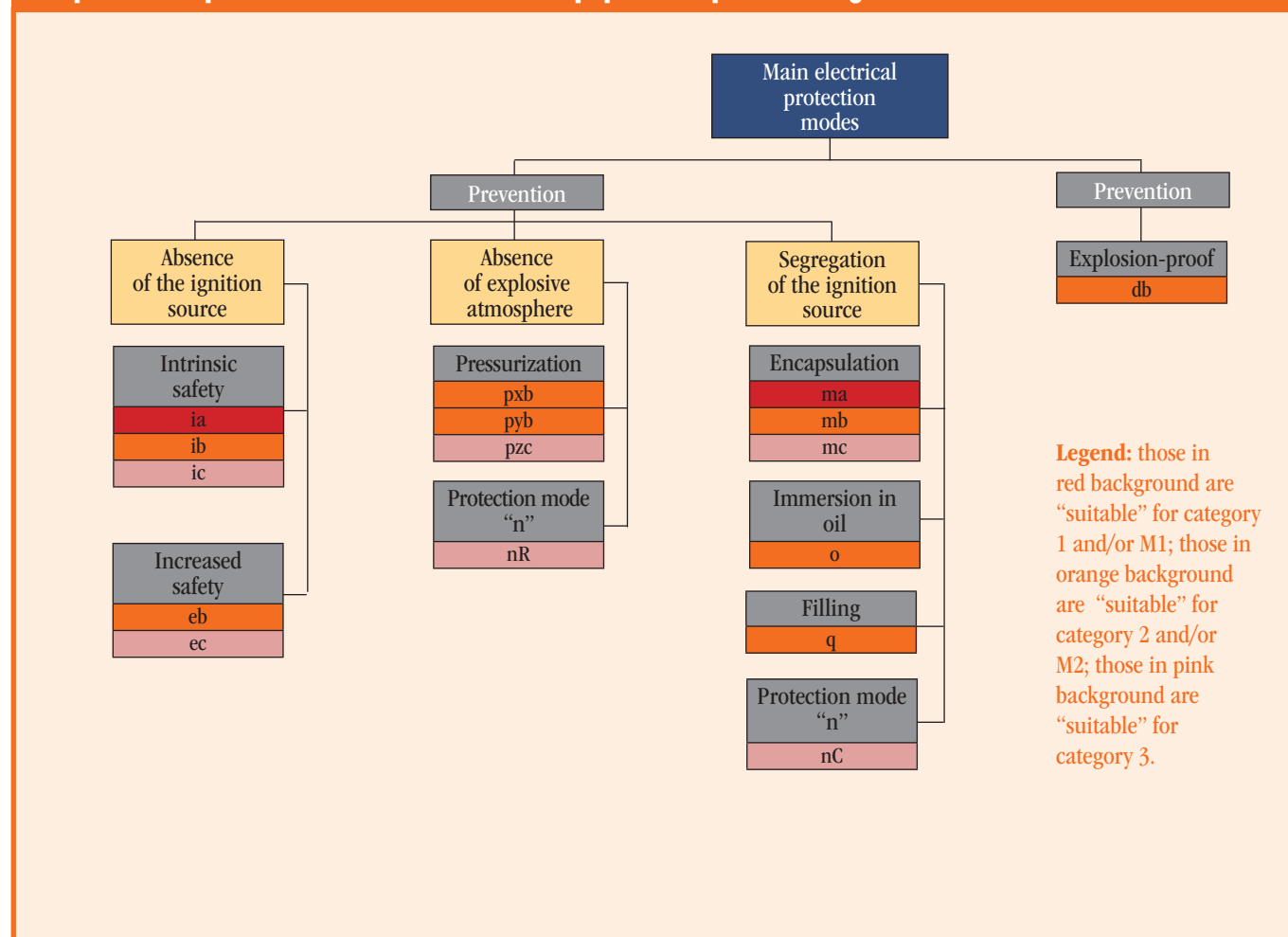

3.3.2. DUSTS

Graph 7 Main protection modes for electrical equipment in presence of dusts

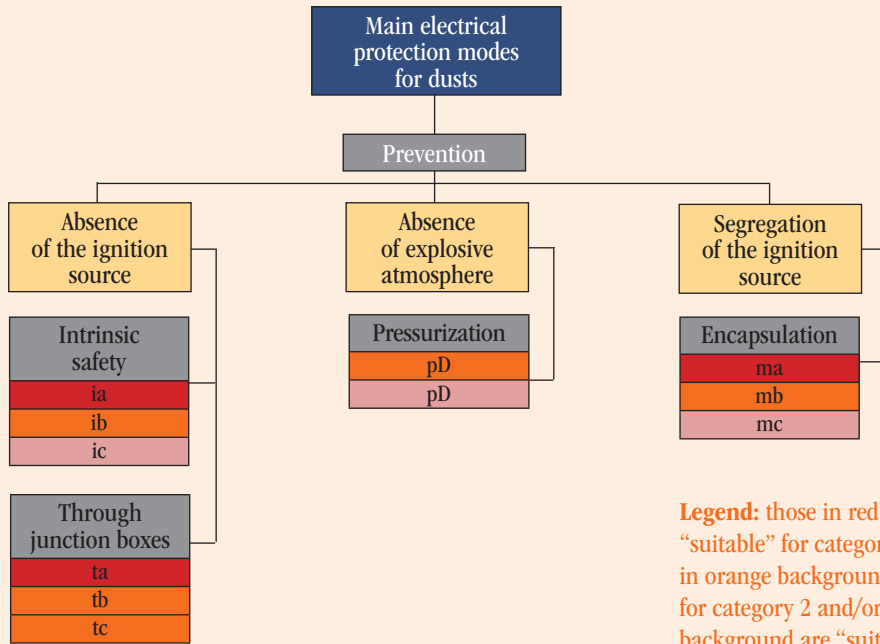

Legend: those in red background are “suitable” for category 1 and/or M1; those in orange background are “suitable” for category 2 and/or M2; those in pink background are “suitable” for category 3.

3.4. NON-ELECTRICAL EQUIPMENT

Graph 8 - Main protection modes for non-electrical equipment in presence of gas or dusts

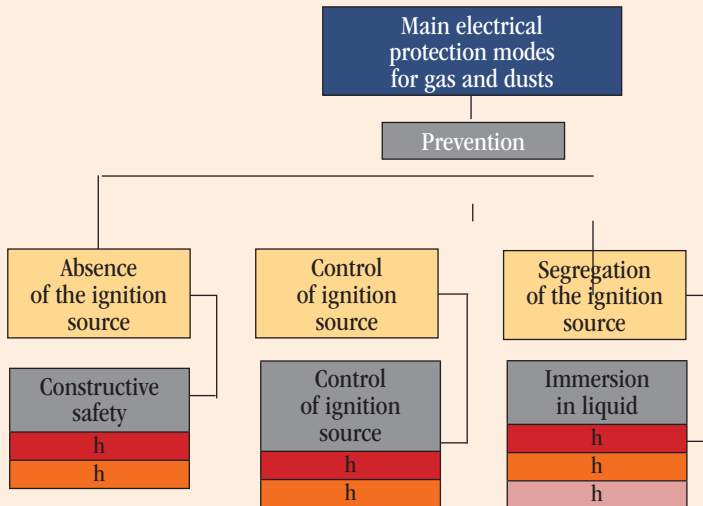

Legend: those in red background are “suitable” for category 1 and/or M1; those in orange background are “suitable” for category 2 and/or M2; those in pink background are “suitable” for category 3.
The protection modes Ex d, Ex p and Ex t can also be used for non-electrical equipment by applying the standards of the 60079 series.

3. Equipment choice

Tab. 12 List and explanation of the letters used in the marking

Capital	Small	Comment
A		<ul style="list-style-type: none"> it appears in gas subgroups of group II: IIA
	a	<ul style="list-style-type: none"> it appears associated to other letters, i.e. ia, ma it appears in the EPL associated to letter G or D
B		<ul style="list-style-type: none"> it appears in gas subgroups of groups II: IIB
	b	<ul style="list-style-type: none"> it appears associated to other letters, i.e.: ib, mb it appears in the EPL associated to letter G or D
C		<ul style="list-style-type: none"> it appears in gas subgroups of group II: IIC it appears associated to protection mode “n”, nC
	c	<ul style="list-style-type: none"> it appears associated to other letters, i.e.: ic it appears in the EPL associated to letter G or D
D		<ul style="list-style-type: none"> it appears associated to p letter: pD it identifies combustible dusts category it identifies the EPL with combustible dusts
	d	<ul style="list-style-type: none"> flame-proof protection mode (both electrical and non-electrical)
	e	<ul style="list-style-type: none"> increased safety protection mode
	f	<ul style="list-style-type: none"> combined to letter “r”, it represents the limited respiration protection mode “fr”
G		<ul style="list-style-type: none"> it identifies gas category it identifies gas EPL
	g	<ul style="list-style-type: none"> protection mode by inherent safety
	h	<ul style="list-style-type: none"> protection mode by source control protection mode by constructive safety protection mode by immersion in a liquid
	i	<ul style="list-style-type: none"> protection mode by intrinsic safety, for gas combined to letters “a”, “b” or “c”
J		<ul style="list-style-type: none"> combined to letter “m”, it represents protection mode for electrostatic spraying “.. mJ”
M		<ul style="list-style-type: none"> it identifies equipment for the mines it could be associated to protection mode “v”
	m	<ul style="list-style-type: none"> protection mode by encapsulation, for gas combined to letters “a” or “b” protection mode by encapsulation, for dusts combined to letter “D” combined to letter “J”, it represents protection mode for electrostatic spraying “.. mJ”
	n	<ul style="list-style-type: none"> protection mode “n” combined to letter: “R”
	o	<ul style="list-style-type: none"> protection mode by immersion in oil combined to letter “p”, optical transmission protection mode “op”
	p	<ul style="list-style-type: none"> protection mode by pressurization (electrical) for gas combined to letters “x”, “y” or “z” protection mode by pressurization for dusts combined to letter “D” combined to letter “o”, optical transmission protection mode “op”
	q	<ul style="list-style-type: none"> protection mode by pulverulent material
R		<ul style="list-style-type: none"> it appears associated to protection mode “n”, nR
	r	<ul style="list-style-type: none"> combined to letter “f”, it represents limited respiration protection mode “fr”
	s	<ul style="list-style-type: none"> special protection mode
	t	<ul style="list-style-type: none"> protection mode by enclosure
	v	<ul style="list-style-type: none"> transportable ventilated cabins protection mode, combined to numbers “1”, “2”, “3”, “4”, or “M2”
	x	<ul style="list-style-type: none"> it appears associated to protection mode “p”, px
	y	<ul style="list-style-type: none"> it appears associated to protection mode “p”, py
	z	<ul style="list-style-type: none"> it appears associated to protection mode “p”, pz



3.5. "Ex" ABCEDARIUM

Looking at the letters used in the previous graphs, it seems that few letters have remained at the "standard-makers' " disposal! We have checked it in the Table 12.

3.6. CORTEM GROUP EQUIPMENT

3.6.1. PRODUCT CLASSES

Since 1968, our company has been designing and manufacturing electrical equipment meant to be used in potentially explosive atmospheres, acquiring competence, year after year, in the regulations of industrial products and becoming specialized in those "Ex". In general, our equipment is used in environments different from the domestic one, and follow certain binding requirements as well as a lot of technical requirements, and both are kept constantly updated.

Image 7



Image 8



Image 7 "Ex d" aluminium alloy enclosure EJB series
Image 8 "Ex ed" stainless steel control station I series

Cortem Group is a multi-product company and, to help the reader find what he is looking for, we have divided the products in "macro areas". Most of our equipment is "Ex", but there are some meant to be also used in non-classified, or safe, areas.

1. "Junction boxes" macro area

The term "junction boxes" itself, for some years part of the common speech of the Ex operators, does not identify anything but a generic enclosure, that generally has the "Ex d" protection method, where it has to be specified the function it will have to perform according to its content. Industrial nomenclature gives us a hand and so our "junction boxes" are:

- "empty involucres low-voltage switchgear and control gear assemblies", in other words all those empty "junction boxes", certified as a component (Image 7);
- "command and control devices", (Image 8) such as automatic switches, command

3. Equipment choice

Image 9



Image 9 "Ex e" Enclosure with terminal strip in aluminium alloy series SA

Image 10 Electronic grounding system in aluminium alloy, series GRD4200 in "Ex d" execution

Image 11 Plug and socket in aluminium alloy, series PY and SPY in "Ex d" execution

switches, disconnectors, control devices – disconnectors and combined unities with fuses, electromechanical devices for control circuits, switching equipment, etc.;

- "low-voltage switchgear and control gear assemblies", such as the switchboards, different sizes, where several "control devices and control gear" can be present, signaling lights, measuring devices, etc.;

- "junction boxes", such as those that are usually called "terminal strips" (Image 9);

- "electrical equipment of the machinery", such as the electrical equipment with a control action on a machine;

- "electrical measuring instruments, analog gauges for direct actions and related accessories", such as ammeters and voltage testers, wattmeters and varmeters, frequency meters, power factor meters, ($\cos \varphi$) and synchronizers, ohmmeters, (impedance meters) and

Image 10



conductance meters, multitasking tools;

- "equipment for tests, measures or monitoring of protection methods", such as systems for the grounding measure (Image 10).

2. "Plugs and sockets" macro area

Our plugs and sockets, with cylindrical cells, with interlocking device, allow the connection also with plugs and sockets of other manufacturers who comply with the product industrial standards (Image 11).

Image 11





Image 12 EVL series lighting fixture with LED in aluminium alloy in "Ex de"

Image 13 Lighting fixture for LED strips in aluminium alloy and glass series LIFEX in "Ex db", "Ex tb" method of protection

Image 14 Fluorescent tubes hand lighting fixture in aluminium alloy FHL series in "Ex d" method of protection

Image 15 Lighting fixture for emergency in aluminium alloy EVF-18EX series in "Ex d" method of protection

Image 16 "Ex de" LED floodlight in aluminium alloy SLED series

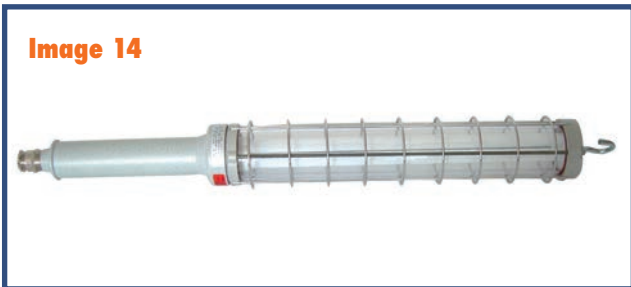

3. "Lighting equipment" macro area

The "lighting equipment" macro area, together with the "junction boxes" one, is an important type of equipment we put on the market and it is divided as follows:

- "fixed equipment for general use" (Images 12-13);
- "portable equipment" (Image 14);
- "emergency" (Image 15);
- "floodlights" (Image 16);
- "street lighting".

Our lighting equipment is codified according to the "International Lamp Coding System - ILCOS", that became international standard (IEC 61231:1020-01) in 2010 and they can be provided with different types of lighting sources, among which the LED "Light Emitter Diode" is of primary importance.

3. Equipment choice

“Signaling devices” macro area.

- “audible warning devices” (Image 17 and 18);
- “visual signaling devices”, that are the devices to signal aerial obstacles, the traffic lights (Images 19 and 20).

4. “Cable glands, systems of pipes and accessories for electrical installations” macro area.

- “cable glands” for armored and unarmored cables (Images 21 and 22);
- rigid and flexible “tubes”;
- “accessories”, such as fittings, curves, reductions, plugs, nipples, etc.

3.6.2. OUR PROTECTION METHODS

As it is evident in the previous chapters, the number of the protection methods currently available is definitely increased (about 26) if compared to the first 6 adopted by the Eco-

nomic European Community quoted in the 79/196/CEE Directive of 6th February 1979. At the beginning, the use of electrical equipment in potentially explosive atmospheres was prevalent in the mining, while its surface use is more recent, dating back to end of IInd World War. Safety used to be quite rudimentary. In late 1800, the coal was the main source for the heating and for the generation of electrical energy. The main danger in the coal mine was and still is represented by the possible presence of fire-damp, a combustible odorless, colorless gas, mainly composed of a mixture of methane (from 77% to 99%) or of other similar hydrocarbons and of varying amounts of carbonic anhydride, oxygen and nitrogen.

The mining history reminds us of the relevant number of workplace fatalities: the most serious mining accidents in the USA (Monongah, West Virginia, December 6th 1907: 362 victims) and in Europe (Courrières, France, March 10th 1907: 1099 victims; Marcinelle, Belgium, August 8th 1956: 262 victims). Therefore, over the years the miners have looked for solutions that could warn them of dangers. Methane is lighter than the air and, consequently, tends to go upwards. So, “canaries in cage” were one of the first safety and warning methods; being

Image 17



Image 17 Acoustic signals in aluminium alloy ETH series in “Ex d” method of protection



LifEx, the shift in the new lighting paradigm.

Less
is
More



We have reduced the size, lowered the weight, shortened the time of installation, removed any type of risk, reduced any maintenance intervention, avoided 70% of the components and saved tons of CO2. **We have also eliminated the possibility of improving it.**

LifEx



www.cortemgroup.com



To be sure to be safe.

3. Equipment choice

Image 18



Image 19



Image 20

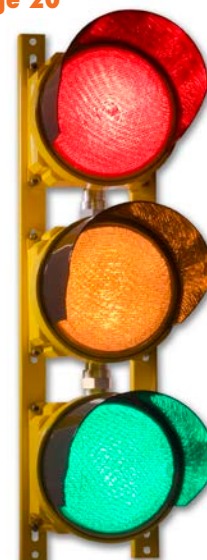

Image 18 Sirens in aluminium alloy ETS60 series in "Ex db eb" method of protection

Image 19 "Ex de eb" LED obstruction lighting fixture complying with ICAO standard XLFE-MIB series

Image 20 LED traffic lights in aluminium alloy CCA-02E/SLD series in "Ex db" method of protection

Image 21 Cable glands for non-armored and armored cables NAV, NEV in "Ex db", "Ex eb", "Ex tb" method of protection

Image 22 Barrier cable glands for non-armored and armored cables NAVB, NEVB in "Ex db", "Ex eb", "Ex tb" method of protection

Image 21



Image 22



very sensitive to gases, when these birds died by suffocation, they were a warning for the miners who immediately run out of the mine. Before Sir Humphry Davy developed the lamp, some oil lamps were used in order to burn the possibly present mixture. I let you guess the consequences!

The introduction of electricity at the end of XIXth Cen. brought some benefits, but also some risks. The first electrical equipment to be used was the lighting one as well as the one generating driving force. Both equipment sets had to be controlled. The problem was analyzed and possible solutions came out. In Germany the mostly involved organization was the Berggewerkschaftlichen Versuchsstrecke (BVS) that, together with the mining engineer Carl Beyling, introduced a technique, around 1905, according to which electrical equipment (lamps and electric motors) was contained in an enclosure strong enough to keep inside the possible explosion



which could be triggered by the electrical equipment. In 1908 Carl Beyling wrote a document describing the application of what was later called “druckfeste kapselung”, that are explosion-proof junction boxes, at that time called “closed encapsulation” or “explosion-proof encapsulation”, from where the letter “d” derives, and stands for the present identification of the protection method. Immediately after that, a second signaling system technique for the mines was introduced, based on the use of low energy values: the intrinsic safety was created.

Today, the term “electrical construction Ex” refers to an electrical equipment for explosive atmospheres that complies with the IEC/EN standards of series 60000.

We have decided to focus on the protection methods we have been designed and manufactured for 45 years. Concerning the protection methods suitable to be installed in presence of explosive atmospheres for gas presence, we will analyze:

- the “Ex db” explosion-proof junction boxes (literally flame-proof);
- the “Ex eb” increased-safety equipment;
- the “Ex n” equipment.

Concerning the protection methods suitable to be installed in presence of explosive atmospheres for combustible dust presence, we will analyze:

- the “Ex tb” equipment.

Below we will indicate for simplicity “Ex db”, “Ex eb” and “Ex tb” with the more generic abbreviations “Ex d”, “Ex e” and “Ex t”.

For a brief description of the other protection methods for gases and dusts, please refer to Tables 27, 28 and 29 in the Appendix.

3.6.2.1. “Ex d” EXPLOSION-PROOF JUNCTION BOXES (LITERALLY FLAME-PROOF)

As described above, the “Ex d” protection method is highly probably the oldest protection method and its applicability to multiple types of industrial products has allowed its great spread (Image 23).

Comparing a normal equipment to an “Ex d” one, the first evident characteristic is the strength of the latter, since it has to resist mechanically, without being deformed plastically, to the internal pressure generated by the explosion. The pressure ranges normally 5 ÷ 20 bar (Image 24). Therefore, in this method, which is the only one based on the explosion containment (held at pressure), the protection is given by the junction box.

The sparking electrical components are enclosed inside the junction box, that allows the explosive atmosphere to enter but, in case of contact between this and the ignition source (arc or spark) the consequent explosion remains confined inside the junction box.

Through the flame-paths (Image 25), the flame cools down and the combustion product is not able to trigger the mixture present outside (held at flame). There are no normative limitations concerning the sizes or the electrical characteristics but, beyond certain dimensional limits building with this technique is expensive.

When choosing the “Ex d” protection me-

3. Equipment choice

thod, the following indications have to be considered:

- do not make further holes in the junction boxes than those allowed in the certificate;
- if the cable entry has a parallel thread, the coupling must have at least 5 full threads;
- if the use of gasket is foreseen, the number of threads must be still sufficient after the insertion of the gasket;
- if the thread is conical, the internal and external ones must be of the same nominal dimension and ensure ≥ 5 threads on every part. Thread must satisfy the NPT recommendation of the ANSI/ASME B1.20.1 standard and ensure a firm sealing;
- if an adapter is required, it must comply with the “Ex d” (IEC 60079-

1) protection method;

- the unused cable entries must be sealed with elements that comply with “Ex d” (IEC 60079-1) protection method.

The cable entry into enclosure can be made by means of three systems:

A. conduit installation;

B. cable installation with direct entry;

C. cable installation with indirect entry.

A. Conduit installation

The electric cables run in a system of rigid conduits and enter explosion-proof boxes by means of sealed fittings. This allows possible explosions to expand and spread inside the housings (Image 26). The outlet of every “Ex d” box features a sealed fitting (Image 27) which prevents explosions from spreading to other sections, delimits the volume of the “Ex d” electrical construction to a value close to that for which it has been proven, and sepa-

Image 23



Image 23 Small control panels in “Ex d” execution. EJB enclosure in aluminium alloy and control devices mounted on lid

Image 24 Explosion-proof “Ex d” method of protection

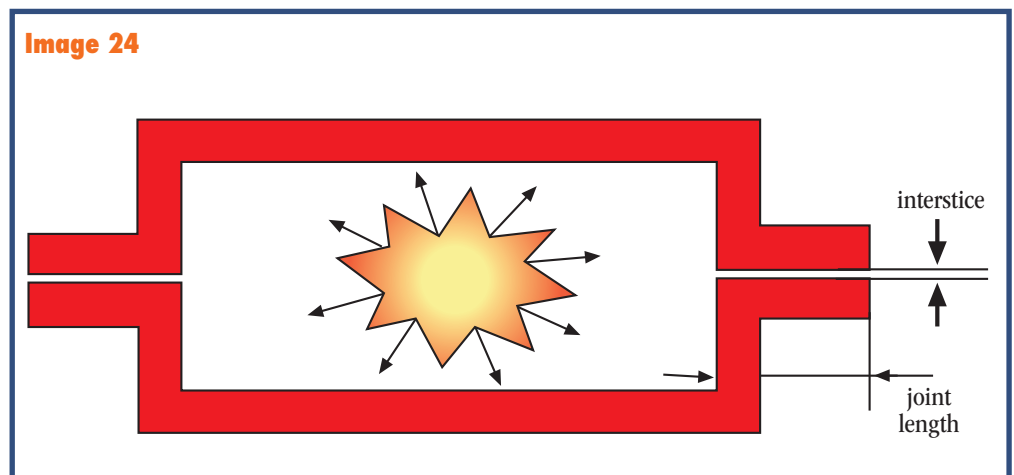

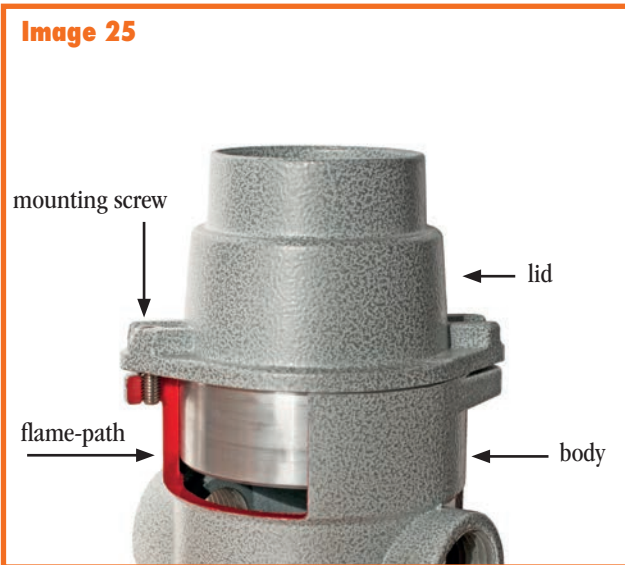

Image 25 Flame-path
Image 26 Conduit installation. Entry in an “Ex d” enclosure through a sealing fitting

rates the conduit installation from a possible part made with external cables.

The wires pass inside a threaded conduit and through a sealed fitting; these sealed fittings must be filled with the right mixture of bi-component resin. This method effectively protects cables against mechanical and chemical damage. One disadvantage is that it is difficult to modify the wiring later on.

B. Cable installation with direct entry

This type of system is mainly used in the UK and in countries under British influence.

Direct entry requires the use of an ‘Ex d’ certified cable gland whose type is specified in the selection criteria for cable glands in the 60079-14 standard (Image 28). Every cable gland must have standard safety specifications and the same internal diameter as the cable used. The gasket must also be explosion-proof. Armored or non-armored cables

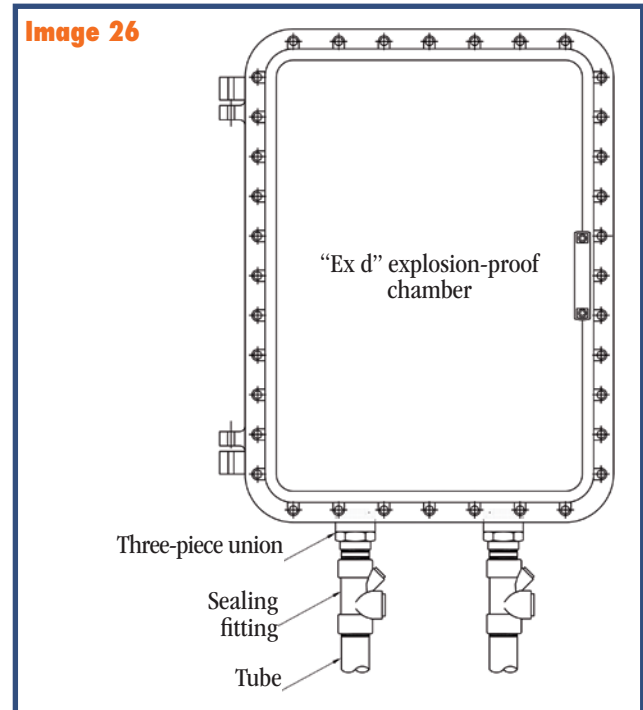

with braid, wires and tapes are used in this installation along with cable gland for armored or non-armored cable. The advantage of this method is that armored cables guarantee both mechanical protection and electrical continuity. One disadvantage is that the cable clamp installation requires special maintenance to guarantee earth continuity.

C. Cable installation with indirect entry

In this system, cables enter and exit a junction box through terminals. By means of sealed bushings, this box is connected to the explosion-proof box which contains houses electrical equipment that may cause sparks. The box containing terminals and the terminals with terminal fittings are both “Ex e” and “increased safety” types (Image 29). This system uses non-armored cables and, therefore, fittings with the right cable glands. This type of installation is therefore used when

3. Equipment choice

Image 27

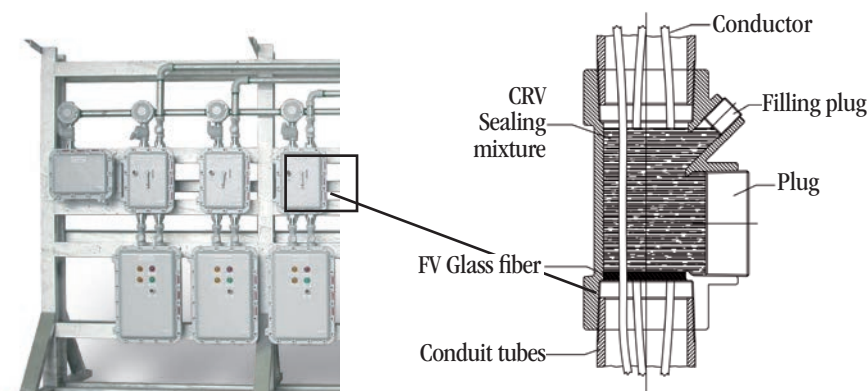
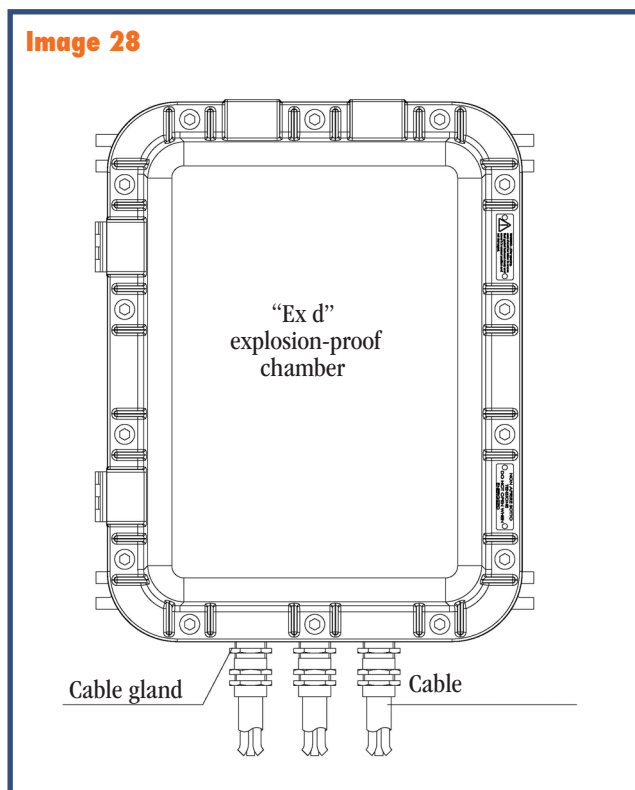

Image 27 Example conduit installation. Between the enclosures, sealing fittings are visible

there is a low risk of mechanical damage. This system is quick to install, flexible and economical. However, it does not effectively protect against the risk of mechanical damage, so it is better to use an armored cable or

Image 28 Cable installation with direct entry



anti-static cable trunking trays wherever this risk is present. Image 30 offers an example of cable installation with indirect entry.

3.6.2.2. "Ex e" INCREASED SAFETY EQUIPMENT

Image 29 Cable installation with indirect entry

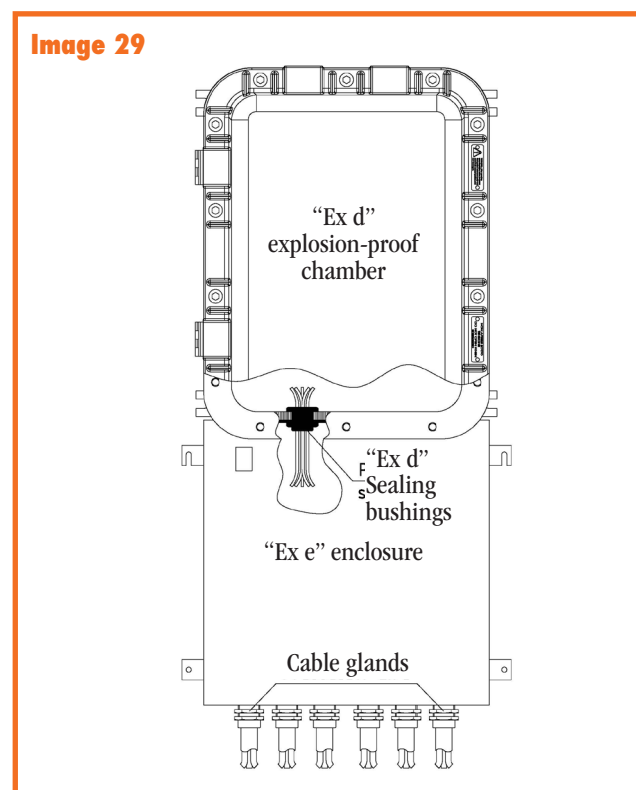



Image 30

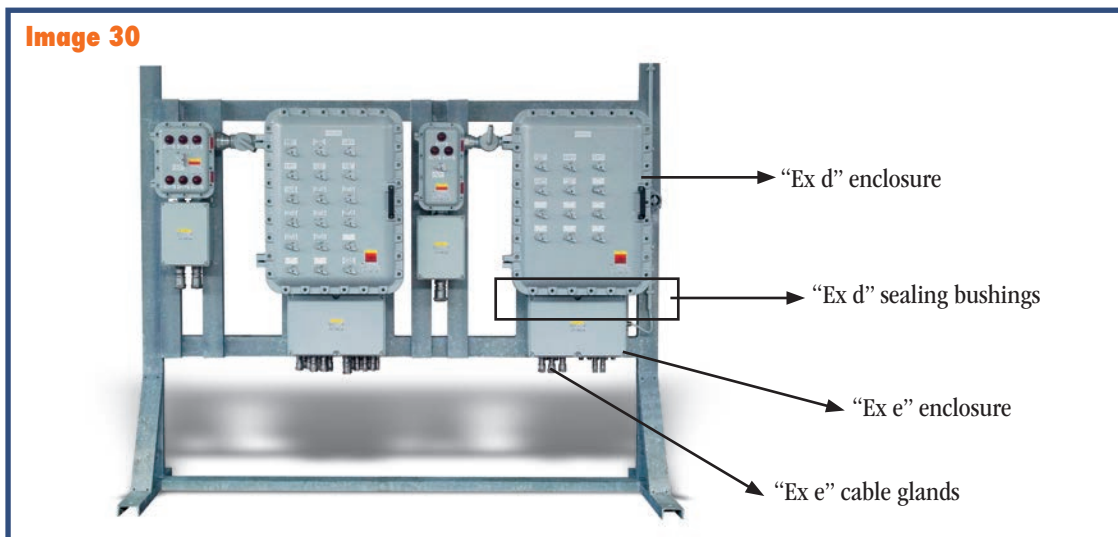

Image 30
Example of cable
installation with
indirect entry

Increased safety equipment is very similar to the industrial one and the term “increased” refers to the safety level which is increased if compared to the one given by the industrial equipment (Images 31 and 32). This protection method imposes some limitations:

- it can be applied to equipment that, while operating, in normal and/or irregular operating conditions, does not produce arcs, sparks or excessive temperatures;
- nominal supply voltage cannot exceed 10 kV.

While installing the equipment, extreme attention must be paid in particular to the four following critical aspects:

- **Protection degree of the equipment.** Enclosures containing active nude parts must have protection degree \geq IP54, while enclosures containing only isolated parts must have protection degree \geq IP44. By contrast, rotary electrical equipment, (terminal strips and nude conductive parts excluded), installed in clean environments and regularly checked by qualified person-

nel, must have enclosures with protection degree \geq IP20. The installation limitations must be specified on the machine. While installing “Ex e” equipment, extreme attention must be paid to those operations that can affect the protection degree, starting with the equipment cable entries. In case solids and/or water enter the equipment, the conductive path between the two live parts of the equipment can be shortened until the break of the dielectric, and consequently an electric arc can be formed.

- **Way in which the equipment is connected to the power supply circuit.** In general, the fuel system of “Ex e” equipment is made with “Ex e” cable gland and certified by a Notified Body, and made with internal sealing ring and external “o-ring”, in order to maintain IP54 degree. The connection between cables and terminals must be carefully taken care of not to reduce the terminals isolation construction characteristics. It means: to fol-

3. Equipment choice

low manufacturer's specifications about the cable cross-section to connect to terminals and about the maximum number of wires connectable to each terminal (or power dissipation of the enclosure); to guarantee, in screw terminals, the tightening of the conductor in the terminal (or of more conductors when the instructions allow it), applying the indicated tightening and being careful not to affect the air insulation distances.

- **Thermal dissipation.** "Ex e" protection method allows the gas to enter the enclosure. For this reason the equipment manufacturer measures the maximum temperature developed by the structure also in the internal components. As the cable inside the enclosure also increases the heat, it is necessary to avoid that temperature exceeds the temperature class declared by the manufacturer at the project ambient temperature (T_{amb}). The instal-

ler must strictly follow the manufacturer's indications about the allowed number of terminals, min and max conductor section, max current and possible indications about the conductors inside the enclosure. It is necessary to calculate the power dissipated by the enclosure that guarantees the respect of the temperature class, considering the resistance of the terminal (declared by the manufacturer) and of the cable, and of the circuit current and of the project ambient temperature (T_{amb}).

- **Choice of protection.** Every single protection method must be always guaranteed. The conformity marking complying with the 60079 standards of the "Ex" equipment, provides the information required to make the right choice and install the equipment correctly, as well as to use it and maintain it properly according to the method of protection it guarantees (Image 33).

Image 31 "Ex e" increased safety protection mode

Image 32 "Ex e" increased safety enclosure SA...SS series in stainless steel with control devices

Image 33 Example of conformity marking

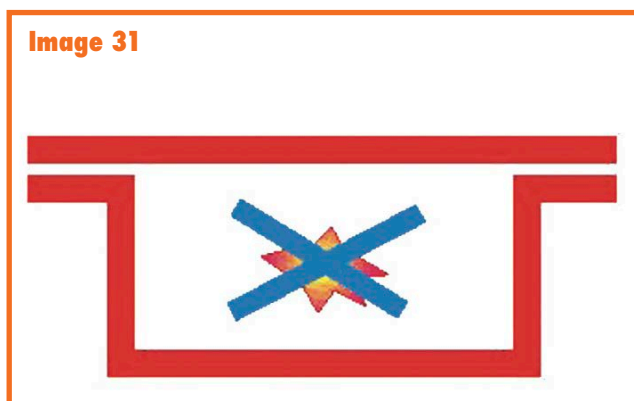

3.6.2.3. "Ex n" EQUIPMENT

For some aspects, it is similar to the increased safety protection method and has different characteristics depending on the equipment: if it is breaking or non-injecting ("Ex nC"), if it is respiration limited ("Ex nR"). In any case, the nominal supply voltage cannot exceed 15 kV.

3.6.2.4. "Ex t" EQUIPMENT

This protection method, introduced as such after the "ATEX 95" Directive 94/9/CE, is about preventing combustible dusts from entering the enclosures where there is the electrical equipment that could cause ignition.

Currently, technical standards classify this equipment under Group III, that has been divided into three subgroups:

- **IIIA:** flammable particles; solid particles, fibers included, with nominal sizes $> 500 \mu\text{m}$;
- **IIIB:** non-conductive dust; finely divided solid particles, with nominal sizes $\leq 500 \mu\text{m}$, with electrical resistivity $> 10^3 \Omega\text{m}$;
- **IIIC:** conductive dust; finely divided solid particles, with nominal sizes $\leq 500 \mu\text{m}$, with electrical resistivity $\leq 10^3 \Omega\text{m}$.

Our equipment has a mechanical protection degree provided by the use of elastomeric material. Such protection degree (IP 6X) has been verified after impact tests and heat and cold tests.

3.6.2.4.1. ENCLOSURES PROTECTION DEGREES (IP CODE)

In the history of the use of electricity, a lot

Image 33



of designers have made efforts to make that plants and electrical equipment could be used safely. Among the various technical solutions adopted to prevent accidents related to electrical systems, there is also the IP code.

The IP code (International Protection) summarizes the protection level of an electrical equipment against the accidental or intentional contact with the human body, objects and water.

Besides the "IP" letters, the code is composed of two significant digits and of the additional letters as indicated in the IEC 60529 standard:

- **first digit (0 ÷ 6):** protection of the people from the contact with dangerous parts and protection of the materials from solids;
- **second digit (0 ÷ 6; 7 ÷ 8):** protection of the materials against harmful effects of water;
- **additional letter:** to be used when the protection of the people against dange-

3. Equipment choice

rous parts is higher than the protection against solids, required by the first digit;

- **supplementary letter:** to be used to provide information about the material.

Explanations concerning the first significant digit are contained in Table 15. The protection level provided is progressive, from the lowest (IPOX) to the highest (IP 6X).

Explanations concerning the second significant digit are contained in Table 16. The protection level provided is progressive:

- about the protection against water, from the lowest (IP XO) to the highest (IP 6X);
- about the effects of the immersion, from the lowest (IP X7) to the highest (IP X8).

Talking about the second digit, two aspects must be considered:

1. between digits 6 and 7, it is as if there was

a border between splashes section and immersion section; it is misleading and makes people think that a IP X7 code is higher than a IP X6 code;







2. IEC 60529 Standard does not give any information about the test of IP X8, but that it cannot have lower conditions than the test for IP X7; it means that defining IP X8 without defining the immersion depth and/or the residence time makes no sense.

Table 17 contains explanations about the supplementary letters related to protection against human access, while Table 18 contains those concerning the supplementary letters related to protection of material.









Some marking examples:

- IP65: equipment that is totally protected from dust and splashes of water;

Tab. 15 IP protection degree: meaning of the first digit

First characteristic digit			
Code	Graphic symbol	Meaning for equipment protection	Meaning for people protection
IP 0X		No protection	
IP 1X		Protected against solid bodies greater than 50 [mm]	Protected against access with the back of the hand
IP 2X		Protected against solid bodies greater than 12 [mm]	Protected against access with a finger
IP 3X		Protected against solid bodies greater than 2,5 [mm]	Protected against access with a tool
IP 4X		Protected against solid bodies greater than 1 [mm]	Protected against access with a thread
IP 5X		Protected against dust	Protected against access with a thread
IP 6X		Totally protected against dust	Protected against access with a thread

Tab. 16 IP protection degree: meaning of the second digit

Second characteristic digit		
Code	Graphic symbol	Meaning for equipment protection
IP X0		No protection
IP X1		Protected against vertically falling water drops
IP X2		Protected against falling water drops with maximum inclination 15°
IP X3		Protected against rain
IP X4		Protected against sprinkles
IP X5		Protected against water splashes
IP X6		Protected against strong water splashes (waves)
IP X7		Protected against temporal immersion
IP X8		Protected against continuous immersion (deep and time declared by the manufacturer)

- IP67: equipment that is totally protected both from dust and splashes of water and from temporary immersion;
- IP65W: equipment that is totally protected from dust, from splashes of water in specified weather conditions (i.e. with ambient temperature $-60 \div + 55^{\circ}\text{C}$).

Sometimes it is required that the protection against solids and/or liquids must comply with the NEMA code instead of the IP code. Table 19 compares NEMA to IP. NEMA code considers also other elements, such as protection against corrosion, factors that IP code doesn't.

3.6.2.5. "Ex de" COMBINED PROTECTION METHOD

It is an equipment, typically a power panel or a lighting equipment, with a part made with the "Ex d" explosion-proof protection method (usually the main part, for example: a power panel or a lighting equipment, Image 34 and 35) and another part made with the "Ex e" increased safety protection method (usually the connection box to the external circuits).

From the union of the two protection methods we have a solution with direct entry:

- "Ex d": a sufficiently strong equipment

3. Equipment choice

Tab. 17 Meaning of additional letters about protection against human access

Additional letters	Description
A	Protected against access with the back of the hand
B	Protected against access with a finger
C	Protected against access with a tool
D	Protected against access with a thread

providing a good safety level and allowing the manufacture of a lot of devices, thanks to its ductility;

- “Ex e”: a connection between equipment and plant providing a good safety level, as well as simple installation and maintenance

Tab. 18 Meaning of additional letters about protection against materials

Additional letters	Description
H	High-voltage equipment
M	Tested against harmful effects due to water ingress with equipment in motion
S	Tested against harmful effects due to water ingress with switched-off equipment
W	Suitable to be used in specified atmospheric conditions

at affordable costs.

3.6.3. MARKING OF EXPLOSION-PROOF EQUIPMENT

As required by IEC 60079-0 standard, each product put on the market has its own identification sign with the following information (Image 36):

- the name or place of the manufacturer, the subject responsible for putting the product on the market;
- the year of manufacture (1), the serial

Tab. 19 Comparison between NEMA code and IP code

NEMA 250	IP (EN 60529 / IEC 60529)
This comparison is based on the concept that NEMA types fulfil or exceed the EN/IEC requirements but they cannot be used to operate a conversion from EN/IEC to NEMA	
1	20
2	22
3R	24
3/3X	55
3S/3SX	55
4	66
4X	66
5	53
6	67
6P	68
7	no equivalence
8	no equivalence
9	no equivalence
10	no equivalence
12	54
12K	54
13	54



number ②, the equipment identification by defining the product code ③);

- the equipment data: the temperature class ④, the maximum surface temperature ⑤, the ambient temperature ⑥, the electrical data as stated in the certificate ⑦ etc;
- data of the Ex aspects, such as the marking, the number of certificate, etc. ⑧;
- notice.

Some data are required by the European Community directives, others are the consequence of the application of technical standards, specific for every equipment.

To understand better the Ex marking, IEC/

EN 60079 defines the composition of the four different sections (Image 37).

- The 1st section is the marking related to the application of at least one European Community Directive: it is highlighted with the graphic sign CE (inserire il logo) with a four-digit number placed nearby to indicate the Notified Body that has to supervise the production (in our case 0722 = CESI).
- The second is the marking related to the application of 2014/34/UE Directive, which it is composed of the European Community mark epsilon-x (inserire logo), of the equipment group (I or II) and of its category (for groups II: 1, 2 or 3) followed

Image 34

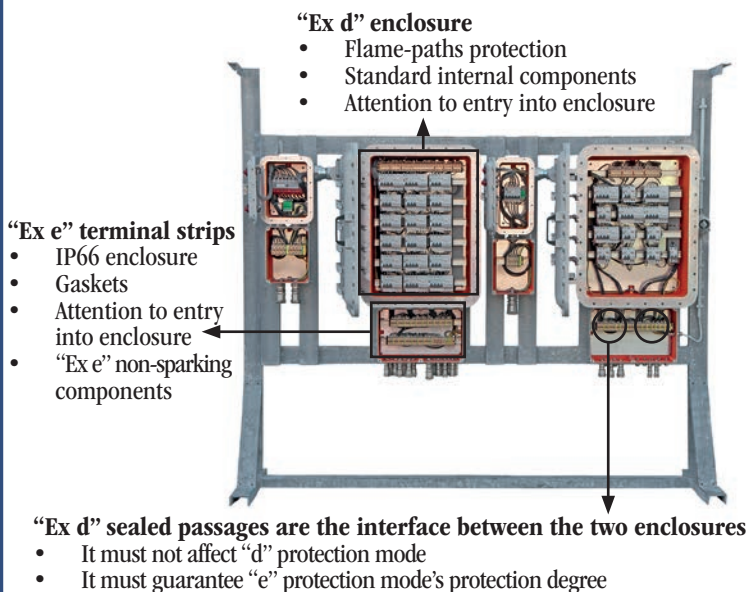

Image 35



Image 34 “Ex de” system EJB series made up of an “Ex d” junction box in aluminium alloy and of an “Ex e” junction box in stainless steel. Image 35 Series EJBE “Ex de” system composed of a “Ex d” EJB series junction box in aluminium alloy and of a “Ex e” CTB series junction box

3. Equipment choice

Image 36 Example of identification plate

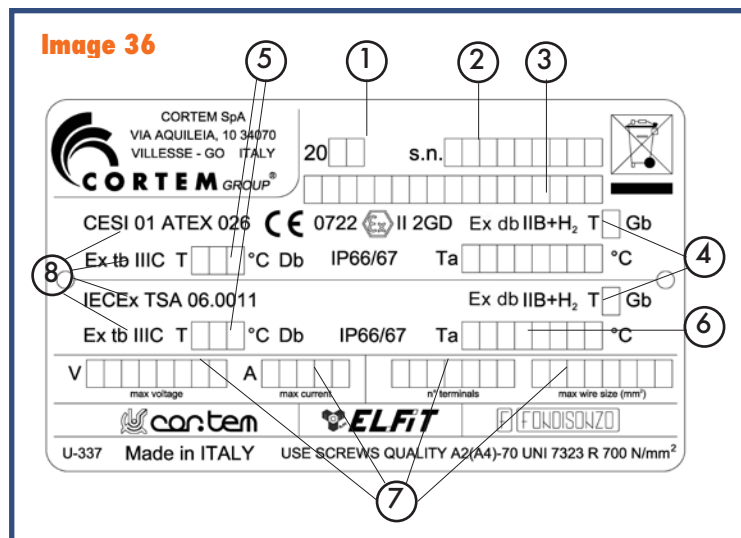
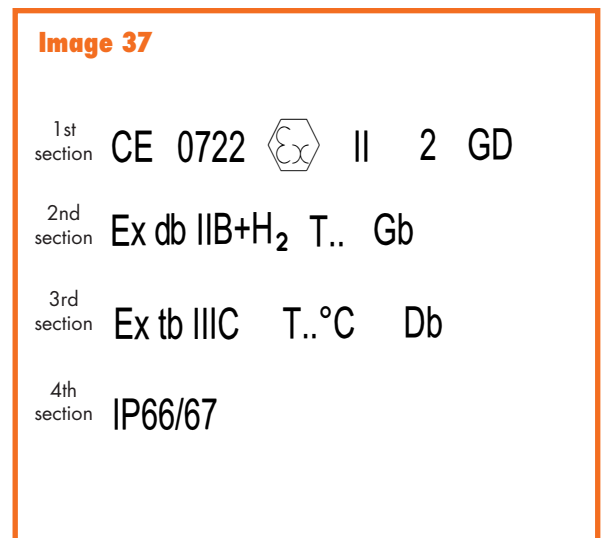

Image 37 Example of Ex marking



by letter “G” for gases or “D” for combustible dusts or “GD” when equipment is suitable both for gas and combustible dusts, the temperature class (ie. T5) and the protection level (EPL) (ie. Gb).

- The third is the marking related to the protection method against dusts and consequent to the application of the harmonized standards such as IEC/EN 60079 standards, the protection method for dusts and dusts groups (ie. Ex tb IIIC), the maximum surface temperature along with ambient temperature (ie. T 135° C) and the protection level EPL (ie. Db).
- The fourth is the marking related to the mechanical protection of equipment from atmospheric agents (ie. IP 66/67).

Some examples of markings on our equipment are contained in Table 20 (following page).

IECEx System (International Electrotechnical Commission System for

Certification to Standards Relating to Equipment for use in Explosive Atmospheres)

In the European Union countries, the compliance with ATEX Directive is a necessary and sufficient condition for the explosion-proof electrical equipment installation in hazardous areas.

Outside the European Union but IEC countries, the explosion-proof electrical equipment conformity to IEC standards must be evaluated by a third part for both general parties and types of protection.

Also here the marking must include: manufacturer name, serial number, identification code, Ex symbol followed by:

- type of protection (d, de, e, ia, ib, ic, nA, nR);
- group (I, IIA, IIB, IIC, IIIA, IIIB, IIIC);
- temperature class or maximum surface temperature (T1, T2, T6, ...);
- equipment protection levels (Ga, Gb o Gc).



North America

American classification and marking follow the method of Classes and Divisions, while both the ATEX European and the IEC international standards follow the method of Areas. Hazardous areas are, therefore, subdivided into 3 classes depending on the type of explosive atmosphere:

- Class I (gases, vapors, combustible mists);
- Class II (dusts);
- Class III (combustible fibers).

Each class is divided into two types of areas at risk of explosion depending on the frequency or duration of the explosive atmosphere formation.

- Division 1: areas with constantly or occasionally dangerous concentrations of gases, vapors or combustible mists during normal operations.
- Division 2: areas without dangerous concentrations of gases, vapors or combustible mist during normal operations but only in case of failure.

It is clear that “Zone 2” of the European classification is the same as the American “Class I Division 2”, while European “Zones 0 and 1” correspond with the American “Class I Division 2”. We can conclude that the equipment specifically designed for use in “Zone 1” in Europe cannot always be used in American “Class I Division 2”.

Compared to IEC zone system:

- Class I only (stated by article 500 in NEC standards) is divided into three zones depen-

ding on IEC standard: Zone 0, Zone 1 and Zone 2;

- temperature classes T1-T6 are the same;
- gases groups IIA, IIB, IIC are the same.

Article 505 allows to choose how to classify, with the aim of giving a global recognition to IEC system, promoting the free movement of equipment suitable for areas classified according to IEC system.

Therefore, products can be approved both by:

• **Classes, Divisions and Groups of substances**

For example: Class 1, Division 2, A, B, C, D T3;

and by:

• **Classes, Divisions and Groups of gases**

For example: Class 1, Area 2, IIA, IIB, IIC, T3.

The Table 21 highlights the differences between North-American and IEC/ European classification.

Explosion-proof equipment must be tested and certified by American Notified Bodies (such as, for example, the Underwriters Laboratories (UL) or Factory Mutual) and by Canadian ones (such as the Canadian Standards Association).

The Image 38 describes the geographical distribution of the ATEX, IEC, NEC and EAC standards, highlighting the countries in which both are applicable and valid.

Russia

The marking of the explosion-proof equipment must comply with the ГОСТ 31610.0-2014 (IEC 60079-0:2011) standards and with the standards concerning

3. Equipment choice

Tab. 20 Ex marking examples

CE marking		ATEX marking			Protection mode					EPL
0	1	2	3	4	5	6	7	8	9	10
CE	0722	Ex	II	2(1)G	Ex	db [ia Ga]	IIB+H ₂	T6..T5		Gb
				2(1)D	Ex	tb [ia Da]	IIIC	T85..100°C	IP66/IP67	Db



CE marking	0	CE	graphic symbol indicating that at least one European Directive has been applied; it is placed only on the equipment, not on the components
	1	nnn	number identifying the Notified Body responsible for the inspection on production; placed on equipment
ATEX marking	2	Ex	“Epsilon-x” European Community mark, specific of the protection against explosions, defined for the first time in the 76/117/CE Directive of 18th December 1975
	3	n	Equipment group I = equipment addressed to underground work in mines and in their surface plants exposed to risk of release of firedamp gas and/or combustible dusts II = equipment not addressed to underground work in mines or their surface plants which could be exposed to risk of explosive atmospheres III = Equipment addressed to environments where there are scarce probabilities that explosive atmospheres occur due to gas, vapors, fog or air and dusts mixtures, also for short time.
	4	xx	Equipment category M1 = equipment addressed to underground work in mines and in their surface plants exposed to risk of release of firedamp gas and/or of combustible dusts. The equipment of this category must stay operative in explosive atmosphere, even in case of exceptional damage of the device. M2 = equipment addressed to underground work in mines and in their surface plants exposed to risk of release of firedamp gas and/or combustible dusts – in presence of potentially explosive atmosphere, it should be possible to interrupt the power supply 2G = equipment suitable for areas where, during normal activities, explosive atmospheres due to gas, vapors or mists (zone 1) may occur; suitable to be installed in Zone 1 and 2 2(1)G = equipment suitable for areas where, during normal activities, explosive atmospheres due to gas, vapors or mists (zone 1) may occur, and that has inside a bonded device that will be connected to a category 1 equipment; suitable to be installed in Zone 0, 1 and 2 2(2)G = equipment suitable for areas where, during normal activities, explosive atmospheres due to gas, vapors or mists (zone 1) may occur, and that has inside a bonded device that will be connected to a category 2 equipment; suitable to be installed in Zone 1 and 2 3G = equipment suitable for areas where, during normal activities, explosive atmospheres consisting of an air and flammable substances mixture in the shape of gas, vapors or mist may occur and, if it occurs, it is really for a short time (zone 2); suitable to be installed in zone 2 2D = equipment suitable for areas where, during normal activities, explosive atmospheres due to a mixture of air and flammable dusts (zone 21) and that has inside a bonded device that will be connected to a category 1 equipment; suitable to be installed in zone 21 and 22 2(1)D = equipment suitable for areas where, during normal activities, explosive atmospheres due to a mixture of air and flammable dusts (zone 21) and that has inside a bonded device that will be connected to a category 1 equipment; suitable to be installed in zone 20, 21 and 22 3D = equipment suitable for areas where, during normal activities, explosive atmospheres in the shape of cloud of flammable dust and, if it occurs, it is really for a short time. (Zone 22); suitable to be installed in zone 22
	5	Ex	It identifies that a protection mode against explosions has been adopted



Protection mode	⑥	α	<p>Letter indicating the protection mode adopted</p> <p>d = equipment protected by a “d” explosion-proof enclosure e = “e” increased safety equipment i = “i” intrinsic safety equipment de = equipment with a part protected by a “d” explosion-proof enclosure and an “e” increased safety part d (ia Ga) = equipment protected by a “d” explosion-proof enclosure with inside an “ia” intrinsic safety associated device (usually a barrier) d (ib Gb) = equipment protected by a “d” explosion-proof enclosure with inside an “ib” intrinsic safety associated device (usually a barrier) nR = equipment designed to limit gas, vapors and mists ingress tb = equipment with an enclosure that prevents dust ingress and with devices to limit surface temperatures; protection level “b” tb (ia Da) = equipment with an enclosure that prevents dust ingress and devices to limit surface temperatures with “b” protection level, with inside an “ia” intrinsic safety associated device (usually a barrier)</p>
	⑦	xxx	<p>I= electrical equipment addressed to firedamp mines and to surface plants exposed to risk of firedamp release. II= electrical equipment for places with explosive atmosphere due to the presence of gas, differs from mines with presence of firedamp, shared in three subgroups IIA; IIB; IIC (IIB+H2 for junction boxes of II group but with presence of hydrogen) III= electrical equipment for places with explosive atmosphere due to the presence of dusts, shared in three subgroups IIIA; IIIB; IIIC.</p>
	⑧	xx	<p>Definition of temperatures generated by equipment</p> <p>T6 = equipment that can reach, but not exceed 85°C of absolute temperature (depending on the protection mode, it can be either maximum temperature or surface maximum temperature) T5 = equipment that can reach, but not exceed 100°C of absolute temperature T4 = equipment that can reach, but not exceed 135°C of absolute temperature T3 = equipment that can reach, but not exceed 200°C of absolute temperature T2 = equipment that can reach, but not exceed 300°C of absolute temperature T...°C = equipment that can reach, but not exceed in surface ...°C of absolute temperature</p>
	⑨	IPnn	Identifies the degree of mechanical protection of boxes, as indicated on Tables 15 and 16.
EPL	⑩	α α	<p>Mb = equivalent to M2 category Gb = equivalent to 2G category Gc = equivalent to 3G category Db = equivalent to 2D category Dc = equivalent to 3D category</p>

3. Equipment choice

Tab. 21 Differences between European/IECEx practice and North-American practice

STANDARD		CONTINUOUS DANGER	OCCASIONAL DANGER	DANGER IN UNSUAL CONDITION
ATEX/IEC 		Zone 0	Zone 1	Zone 2
	NEC 500	Class 1, Division 1		Class 1, Division 2
	NEC 505	Class 1, Zone 0	Class 1, Zone 1	Class 1, Zone 2

the single protection methods. The marking must contain:

- the protection level;
- the Ex symbol;
- the symbol of the type of protection applied;

- the equipment group (I, II or IIA, IIB, IIB);
- the temperature class;
- and the symbol X, if certain use conditions must be followed or if the product is an Ex component.
- year of construction;
- serial number;
- ambient temperature (use);
- certificate number;
- product code.

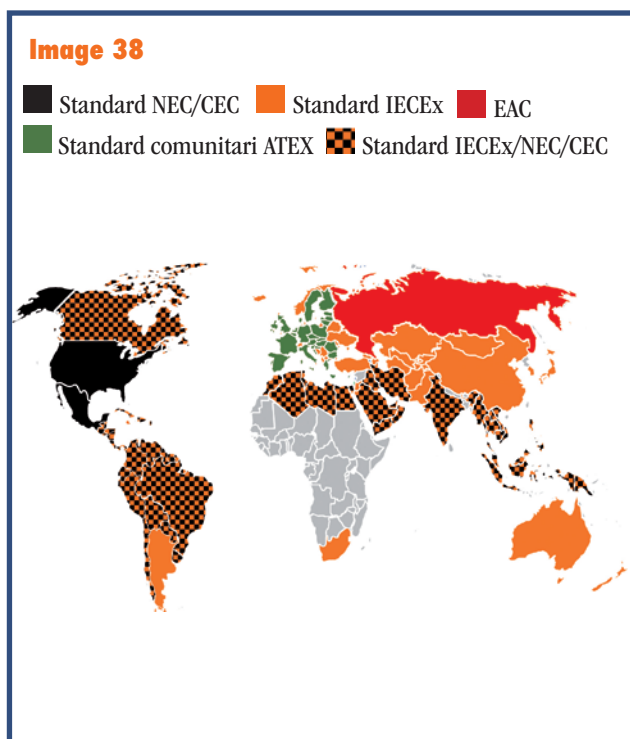

Image 38 Geographical distribution of the ATEX, IEC, NEC and EAC standards

3.6.4. THE AMBIENT TEMPERATURE OF OUR EQUIPMENT

The ambient temperature is the air temperature or the temperature of another material very close to the equipment. Usually, for Ex equipment, the interval considered is $-20 \div +40$ (°C). For the Cortem Group equipment the interval is wider: $-60 \div +60$ (°C) to meet the needs of extreme areas where our equipment is installed. To do so, we have looked for materials suitable to this temperature range.



3.6.5. OUR TEMPERATURE CLASSES

The temperature class is the maximum surface or absolute temperature, depending on the protection method, that the equipment can reach while operating.

The less the equipment heats up, the fewer are the chances that they cause an explosion.

The average ignition temperature of the classified gases is about 360°C (T₂) – see Graph 5, chapter 2.

Find comparison between European/International and North-American temperature classes in Table 22.

3.6.6. MATERIALS USED IN OUR EQUIPMENT

Today, we use many different materials for producing equipment and components designed for areas with a potentially explosive atmosphere. They can be basically classified in Table 23.

When choosing the best materials to be transformed into finished products, it is important to consider the limiting factors of nature. All materials, including the ones we use, have three enemies:

- environment;
- temperature;
- time.

Temperature and time are familiar factors, while the environment, where our products are used, is not easy to control.

We are not talking about familiar potential hazards caused by an explosive atmosphere

(which can be controlled by laboratory tests and guaranteed by certification), but rather deterioration caused by highly aggressive environments like chemical and petrochemical plants.

Corrosion resistance is a relative factor, as it depends on the actual environmental conditions that significantly influence the nature of the attack.

This is why Cortem Group constantly tests its materials in accordance with ASTM standards (American Society for Testing and Materials) – for example B117 in salt fog, G31 in hydrogen sulphide and hydrochloric acid, etc. - and carries out in-depth research into their resistance in outdoor environments. It is therefore able to choose the right material based on objective experience and to guarantee long-term product safety.

3.6.6.1. ALUMINIUM ALLOY





Aluminium alloy is one of the world's most widely used materials in the production of explosion-proof enclosures.

It is highly corrosion-resistant and, therefore, universally known as the most effective and versatile material for most applications.

It is much lighter than cast iron, so it makes the equipment much easier to install and maintain; moreover, it is highly corrosion-resistant and does not require surface protection, unlike cast iron which has to be galvanized or coated.

3. Equipment choice

Tab. 22 Comparison between European/international and North-American temperature classes

[°C]	[°F]	 	 
450	842	T1	
300	572	T2	
280	536		T2A
260	500		T2B
230	446		T2C
215	419		T2D
200	392	T3	
180	356		T3A
165	329		T3B
160	320		T3C
135	275	T4	
120	248		T4A
100	212	T5	
85	185	T6	

Nevertheless, Cortem Group protects its products with a surface coating, RAL 7035, that contains stainless steel particles, a protection against mechanical impact, and characterizes our production avoiding imitations and fake products.

Aluminium is also much cheaper than stainless steel. The mechanical properties of aluminium alloy castings are more than adequate for ensuring explosion-proof elec-

trical protection.

In the past, either aluminum-copper alloys were used, but they were not at all corrosion-resistant, or aluminium-magnesium. Although being corrosion-resistant, magnesium, when mechanically hit, can generate sparks with energy values able to trigger an explosion (technical standards limit the magnesium presence at 7,5% in mass). Today we use the aluminum-silicon alloys, where copper is present as impurity. Its main features can be summarized as follows:

- fairly high mechanical resistance;
- adequate ductility;
- good denseness;
- corrosion resistance.

The aluminium- silicon alloys we use mostly are the AlSi10Mg(a) (EN AB 43000) and the AlSi12(b) (EN AB 44100), and their chemical compositions, in accordance with EN 1706 standard, are contained in Table 24.

3.6.6.2. STAINLESS STEEL

The stainless steels, because of highly aggressive environments or for technical/legislative reasons (for example in the food and pharmaceutical sectors), have been so much requested in the last years, that almost all our equipment is being made also of this material, regardless of the protection method.

The stainless steels are iron-, coal- and chrome-based alloys that combine the mechanical properties typical of carbon steels with the corrosion resistance properties, due to a thin and transparent surface layer called “passiva-



tion layer”. It is formed when the materials of the alloy come into contact with the air or water oxygen.

The stainless steels are traditionally divided into three big families, depending on their metallographic structure:

- martensitic;
- ferritic;
- austenitic.

In order to meet the market needs, such as providing highly resistant materials to chloride corrosion, we have chosen the AISI 316 (X5CrNiMo17-12-2) stainless steel, belonging to the austenitic family.

In general this family has the following properties:

- high corrosion resistance;
- ease of cleaning and excellent hygienic coefficient.

But stainless steel presents also some disadvantages:

- in low temperatures the corrosion resi-

stance decreases dramatically. Acids break the oxide film creating generic corrosion in these steels;

- in the interstices and in the protected areas, oxygen quantity may not be sufficient to preserve the oxide film, and may therefore provoke interstitial corrosion;
- halide ions, especially the (Cl-) anion, break the passivation film on the austenitic stainless steels and provoke the so-called corrosion to alveoli (called also “pitting corrosion”); another chlorine’s effect is the SSC (Stress Corrosion Cracking).

Chemical composition, in accordance with EN 10088 standard, is contained in the Table 25.

3.6.6.3. POLYESTER REINFORCED WITH GLASS FIBERS

This material appeared in Italy in the Ex sector in the second half of the 80s, and was ap-

Tab. 23 Materials used by Cortem Group for the production of explosion-proof equipment

	Metallic material	Plastic materials	Transparent parts
Equipment external part	<ul style="list-style-type: none"> • aluminium alloys • stainless steel 	<ul style="list-style-type: none"> • reinforced polyester with glass fiber 	<ul style="list-style-type: none"> • borosilicate glass • polycarbonate
Gaskets	<ul style="list-style-type: none"> • neoprene, silicone 		
Ex entry	<ul style="list-style-type: none"> • nickel-plated brass • aluminium alloy • stainless steel • galvanized steel 	<ul style="list-style-type: none"> • polyamide 6 	

3. Equipment choice

Tab. 24 Chemical composition of aluminum-silicon alloys

	Fe	Si	Mn	Ni	Ti	Cu	Pb	Mg	Zn	Sn	other
AlSi10Mg(a)	max 0,55	9 ÷ 11	max 0,45	max 0,05	max 0,15	max 0,05	max 0,05	0,2 ÷ 0,45	max 0,1	max 0,05	each 0,05; total 0,15
AlSi12(b)	max 0,65	10,5 ÷ 13,5	max 0,55	max 0,1	max 0,2	max 0,15	max 0,1	max 0,1	max 0,15	//	each 0,05; total 0,15

plied mostly in the increased safety derivation boxes.

The material we use is an unsaturated polyester resin, reinforced with glass fibers to improve its mechanical characteristics, and graphite, to make the surface “conductive” in order to reduce the risk of accumulation of electrostatic charges; graphite provides the typical dark grey color.

Fibers are highly traction-resistant and represent, therefore, the resistant elements of the fiber-reinforced material.

In fact, when a fiber-reinforced material undergoes an axial traction, the real efforts are absorbed by the fibers, while the polymer matrix has only to distribute them to the fibers, leveling the stress.

Moreover, the resin protects the fibers from the wear and ensures a good fiber alignment.

Thanks to flame retardants present in the chemical formulation, our material complies also with Vo degree according to UL94 standard.

The main properties are:

- high lightness;
- high mechanical resistance;
- high thermal insulation;
- high dielectric and magnetic properties.

3.6.6.4. BOROSILICATE GLASS

Borosilicate glass is a strong material, known for its resistance to thermal shocks and for its low expansion; it is resistant to chemical agents and has excellent features of transparency.

For our equipment we use the one in class 3.3, in accordance with ISO 3385 standard, that has the following characteristics:

- smooth, non-porous surface, easy to clean;

Tab. 25 Chemical composition of stainless steel AISI 316

	C	Si	Mn	Ni	Cr	Mo	N	other
X5CrNiMo17-12-2	≤ 0,07	≤ 1,00	≤ 2,00	10,0 ÷ 13,0	16,5 ÷ 18,5	2, ÷ 2,5	≤ 0,11	each ≤ 0,03; total ≤ 0,045



- excellent and wide chemical compatibility; it is moreover highly resistant to water, salt solution, organic substances, halogens and acids;
- no catalytic effect in chemical processes;
- no harmful physiological characteristic in biochemical process;
- transparency;
- good stability and thermal resistance;
- low thermal expansion.

The chemical composition, adherent to ISO 3585 standard, is contained in the Table 26.

3.6.6.5. POLYCARBONATE

Polycarbonate (PC) is a generic polyester of carbonic acid. Notwithstanding Du Pont has studied it as a possible cotton fiber replacer since the end of the 20s, it is the most recent among the materials above described since Bayer (Makrolon®) and General Electric (Lexan®) started its commercial use in the 60s. The polycarbonate we use is of bisphenol-A, a polymer composed of many (“poly”) identical units of bisphenol A connected to carbonate in the main chain. Main features of this thermoplastic material are:

- transparency: high refractive index due to its aromatic feature; transparency and absence of color allow a light permeability of 89% in the visible spectrum;
- thermal and mechanical resistance;
- resistance to mineral acids, hydrocarbon, petrol, greases, oils, alcohols (except methyl alcohol) and water under 70°C;
- good electrical properties.

3.6.6.6. NICKEL-PLATED BRASS

We use this material (leaded brass with Cu 58%, Zn 40% and Pb 2%) exclusively for the construction of Ex cable entry (Cable glands). Besides the traditional copper (Cu) and zinc (Zn) alloy, our material has also a low lead (Pb) percentage on the external part of the bar, which simplifies the turning since it does not create a solution with the alloy Cu-Zn, and since it has a lower solidification temperature than the other two elements. Subsequently, it undergoes a surface treatment of electrolytic nickel plating, to provide the product, more than with an aesthetic aspect, with a higher corrosion-protection level by external agents.

3.6.6.7. GALVANIZED STEEL

We use even this type of material, an iron (Fe) carbon (C) alloy, as well as nickel-plated brass, for connection elements of Ex entries. It is a stainless steel, sweet, for general use, with small amounts of lead, bismuth, tellurium or sulfur. To protect the component from corrosion, at the end of machining it undergoes a galvanizing process.

3.6.6.8. POLYAMIDE 6

We use also this material, as well as the previous ones, exclusively for the construction of Ex cable entries. The polyamides (Pa) are linear polymers characterized by the presence of the amide group -NH-CO-. In the range of polyamides, commonly known as “nylon”, different types may be distinguish-

3. Equipment choice

Tab. 26 Chemical composition of borosilicate glass 3.3

	SiO ₂	B ₂ O ₃	Na ₂ O	Al ₂ O ₃	other
Borosilicate glass, class 3.3.	80,6 %	12,5 %	4,2 %	2,2 %	0,5 %

shed. The single types of polyamide do not differ much: relatively low specific weight, resistance to impact and wear, discreet electrical insulation, resistance to solvents, oils, greases and fuels. We use the polyamide 6 (Pa6) or polycaprolactam, that belongs to the family of aliphatic polyamides.

3.6.6.9. NEOPRENE

Neoprene is one of the main materials we use for our seals. The neoprene (originally called duprene) was the first residue of the synthetic rubber produced in a large scale with more than 75 years of proven performance in a wide spectrum of areas. It was originally developed as oil-resistant replacer for natural rubber.

The basic chemical composition of the Neoprene synthetic rubber is polychloroprene (CR). It belongs to the family of elastomers synthesis (i.e. synthetic rubber) and it looks like a porous rubber, whose mass is made up of gas cells uniformly distributed. The main features are: the elasticity, shear strength and crushing, resistance to aging, air pollution and heat, and, moreover, it appears to be inert towards many chemical agents, oils and solvents.

3.6.6.10. SILICONE

The silicone, as well as the neoprene, is one of main materials we use for our seals. Silicones or polysiloxanes (methylvinyl polysiloxane) are inorganic polymers based on a silicon-oxygen chain and organic functional groups (R) linked to the silicon atoms. Typically, the silicone rubbers (VMQ) are remarkably resistant to temperature, chemical attack and oxidation, and are excellent electrical insulators. They are excellent non-stick, flexible, resistant to aging and to high temperatures.

3.6.7. OUR CERTIFICATIONS (PART I)

3.6.7.1. THE 2014/34/UE DIRECTIVE

Most of the equipment we produce belongs to group II, category 2G and 2D. On the basis of this and considering that it is electrical equipment, our conformity assessment procedures were aimed to obtain the various CE type-examination certificates for the design aspects of the Ex equipment and the notification of product warranty (Image 39) to cover the manufacturing aspects of the equipment itself.

Even if it is not required by the conformity assessment procedures of the directive, for greater transparency to our customers, **our equipment belonging to categories 3G and 3D underwent the design assessment obtaining the type-examination certificate.**

To satisfy essential safety and health requirements we use the harmonized standards.



Representing the state of the art, they are in continuous evolution (a standard is valid for about 5 years). The Official Journal of the European Union (OJ) publishes periodically, on C series, the list of standards satisfying the essential requirements of each Directive issued by the Union and defines the end date of the presumption of conformity with the requirements themselves.

Therefore, our certificates are always updated so that our equipment projects meet the state of the art present when we put the products on the market.

Moreover, another choice we made was to use Notified Bodies whose competence, impartiality and rigor are internationally recognized.

3.6.7.2. IEC-EX

Since the beginning of 2000, outside EU a voluntary certification scheme has been applied internationally. We talked about it in chapter 3.6.3.: IECEx (<http://www.iecex.com/>) scheme.

This scheme is very similar to that of the 2014/34/UE Directive and foresees both the design control (Ex-TR) and the manufacturing control (QAR) by a Certification Body accredited by this scheme. With these two documents it is possible to require the conformity certificate (CoC). The reference standards are those of the IEC 60079.

The IECEx system aims to facilitate the international marketing of equipment meant to be issued in the environment with explosive atmospheres, maintaining the necessa-

ry safety level:

- reduction of trial and certification costs for the producer;
- reduction of the time to market;
- international confidence in the product assessment process;
- an international database;
- maintenance of a confidence level towards the equipment and the services expressed in the IECEx certification.

This scheme and its certificates are recognized internationally by more and more countries.

Certificates by IECEx system are issued as “electronic certificates” and are available on IECEx website (Image 40). This allows public access in order to view and print.

3.6.7.3. RUSSIA EAC

Image 39 ATEX Certification of production quality

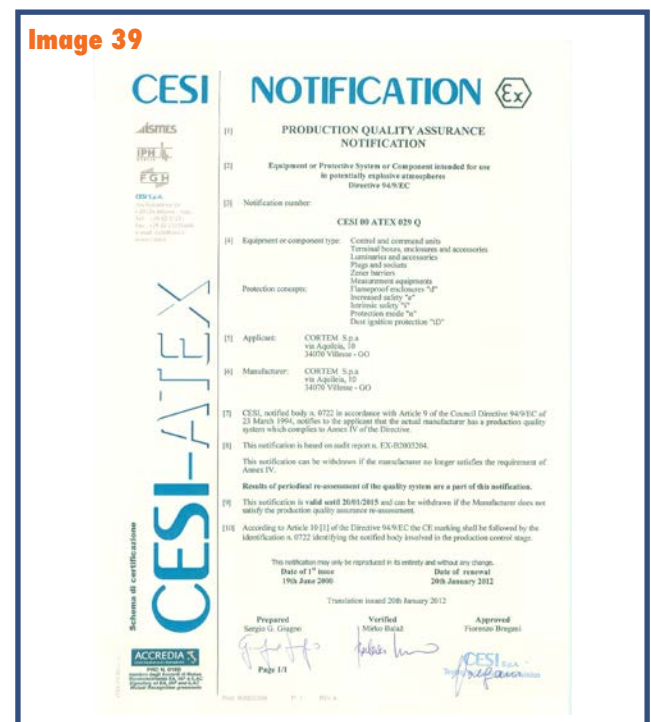

3. Equipment choice

Standards in Russia are very different from the European contest, where we can move easily. In the EU we find the principle of mutual recognition, and the mandatory certification (CE mark) is required only for certain hazardous product families or products associated to serious risks; by contrast, in Russia, according to the law No. 508 of 22/07/92 on the defense of consumer rights, most of the products meant to be marketed within the confederation, must be certified to verify the product conformity to the Russian national standards.

Since the safety and quality control of the imported products does not depend on the custom bodies, they verify only presence and authenticity of documents certifying the imported product properties.

In the Customs control of goods, the main document is the certificate of conformity issued based on safety requirements of the Technical Regulation of the Euroasiatic Customs Union. In the field of EAC certifications, the normative about equipment to use in hazardous areas (so with ex-proof features) is based on the Technical Regulation 012/2011 of Euroasiatic Customs Union, one of EAC Technical Regulations in effect since 2013. These regulations, continuously updated and developed, gradually came in from the 2012, covering at the end of 2015 the majority of product market which regulate the production for the markets of Russia, Belarus, Kazakhstan, Armenia and Kirghizistan. The EAC Ex certificate derives from the compliance to the TR CU 012/2011, and it is equivalent to ATEX certificate.

Image 40

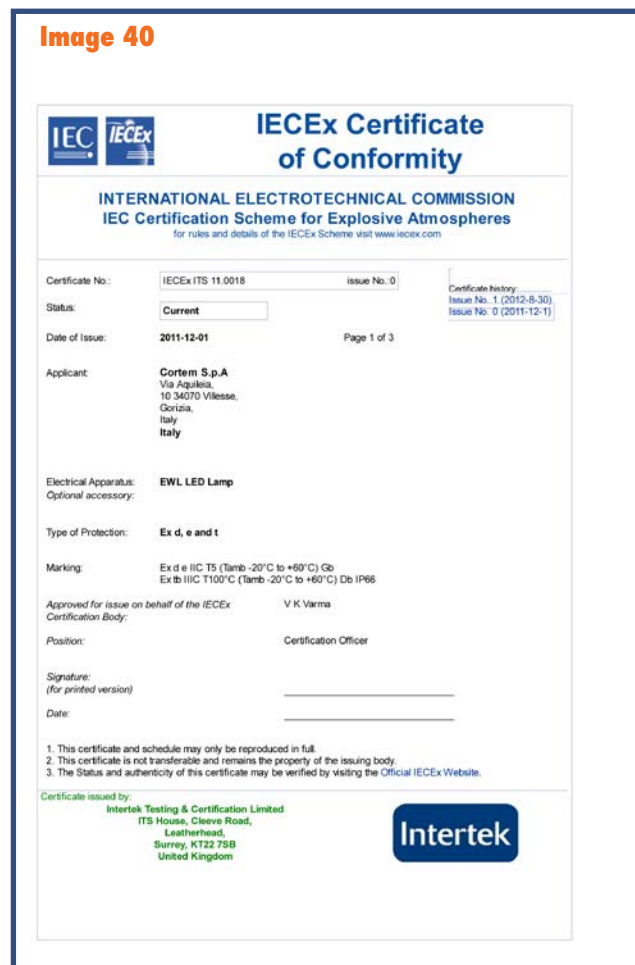

Image 40 Example of certificate IECEx

EAC Ex certificate - Products subject to the normative

The Technical Regulation 012/2011 is addressed both to electrical equipment and its components and to those which do not use electricity supply.

Products following the features listed by the regulation, are identified through the presence of the specific Ex marking placed on product and on its related documentation, hence the common name “EAC Ex certificate”. EAC refers to the unified normative of Customs Union of which Russia, Belarus and Kazakhstan are part and which adhere to the certifications system;



Image 41 EAC certification

while Ex refers to the ex-proof properties of the product.

TR CU 010/2011 on safety of equipment and plants

TR CU 010/2011 concerns the regulation about the commercialization of a wide range of equipment on the Russian Federation, Belarus, Armenia and Kirghizistan area. The technical regulation is not applied to sectors such as medical, telecommunications, marine, air, railway and military.

EAC certificates of Euroasiatic Customs Union according to the TR CU

regulation

Certificates of Customs Union are intended as compliance documents that at the moment are the most important in force inside Russian Federation, Kazakhstan and Belarus, and represent present and future of certification inside EurAsEC area. Nine countries are part of Euroasiatic Economic Community: Russia, Belarus, Kazakhstan, Uzbekistan, Tigikistan, Ukraina, Moldavia and Armenia. At the moment, of these nine Republics of Ex Soviet Union, only three countries (Russia, Belarus, Kazakhstan) from 2012 are part of the EurAsEC Customs Union, with the aim of a complete economic, commercial and perhaps monetary integration. The Customs Union permits free circulation of good inside economic community.

Basically, from one side the need of a uniform certification body is realized through the creation of two new institutes: the Compliance Declaration and the Compliance Certificate of EurAsEC Customs Union; from the other side, through a series of technical regulations (Technical Regulations of Customs Union) according with the World Trade Organization WTO, recognised by the TS TR acronym. The products labelled with EAC comply with the applicable standards and have received a EAC certificate by an accredited certification body. Therefore, they can be custom cleared only if they have this certification issued by a Russian official body accredited by

Rosakkreditatsia; the certificate of conformity must be shown together with the cargo customs declaration and is fundamental to import the products into the Russian Federation.

Deliveries with official copy of the certificate will be custom cleared and will be accepted by the Russian customer.

Extra permissions are required for many products meant to be used in industrial and potentially hazardous areas based in Russia, among which we find the Ex equipment (ie. sectors as nuclear, naval etc).

3.7. OUR CERTIFICATIONS (PART II)

On each product put on the market, the subject applying the **CE** mark must:

- prepare the “UE conformity statement” for devices, or the “conformity certificate” with the embedding conditions for components;
- provide the user instructions.

From a legal point of view, the EU considers “**producer**”:

- i) the manufacturer of the product defined in the European Community and every other person who introduces him/herself as manufacturer by applying on the product his/her name, label, or still who makes the product new;
- ii) manufacturer’s representative, if the manufacturer is not defined in the European Community, or the importer of the product itself;
- iii) the other professional operators if their

activity affects the product safety features. Let’s have a further look at these two documents.

3.7.1. THE “UE CONFORMITY STATEMENT”

The “UE conformity statement” is the formal and final act in which the producer declares to the single market of the European Union, that he has followed the Essential Safety and Health Requirements of all the community Directives.

The UE conformity statement are prepared considering the following legislative and normative references:

- annex X “UE conformity statement” of 2014/34/UE Directive of the EUROPEAN PARLIAMENT AND BOARD of 26th February 2014, concerning the armonization of legislations of the members States about equipment and protection systems addressed to be used in potentially explosive atmosphere (recast);
- ISO/IEC 17050-1 and 17050-2 technical standards “Evaluation of conformity - conformity statement issued by the supplier”.

Depending on the applied Directives, particular extra requirements can be made, such as:

- the “Low tension” Directive requires the last two digits of the year in which the CE mark was applied;
- the “machinery” Directive requires the description and the identification of the machinery, with generic denomination,



function, model, type, serial number, commercial denomination;

- 2014/34/UE Directive requires, if it is given, name, identification No. and address of the Notified Body that issued the CE type-examination certificate and the certificate No.

3.7.2. "USER INSTRUCTIONS"

Instructions provide information about the correct use of the product in safety conditions; for this reason they are written not only in the language of the producer, but also in English.

Instructions are part of the product supply.

Also in this case, instructions are prepared considering the following legislative and normative references:

- IEC 62079 Technical standard "Preparation of instructions – structure, content and presentation";

Depending on the applied Directives, specific requirements can be found, such as:

- the "machinery" Directive requires at least a series of information defined in chapter 1.7.4. and/or in chapter 3.6.3 and/or in chapter 4.4, etc. of annex I;
- 2014/34/UE Directive requires at least a series of information defined in chapter 1.0.6 of annex II. ■



Fig. 42 Cortem Group safety, use and maintenance instruction example

4. Installation



Safety in the potentially explosive areas can be guaranteed only with a tight and effective collaboration among all the parts involved (Image 42).

The employer is responsible for the safety of his plants. He must verify where there is a risk of explosion and subdivide the zones into Areas. He must guarantee that equipment is installed in accordance with the standards and that it is checked before its use. Moreo-

ver, he must verify that equipment is properly used, and carry out periodical inspection and maintenance activity.

Installation design, equipment choice and assembly must be carried out by competent personnel trained in the different protection and installation methods, as well as in the rules and legislative standards about areas classification.



Producers of explosion-proof electrical equipment are responsible for routine tests, product certification and documentation. They have to guarantee that each device complies with the approved design.

After that, the installer will have to consider both normative standards (such as the IEC/EN 60079-14) and what is reported on the user instructions provided by the manufacturer, in particular if there are “special conditions for safe use – (X)”.

Our choice of cable glands for “Ex d” equipment is relevant. Cable glands following “Ex d” protection method can be of different types, depending on their use. Generally, they are divided into two categories:

- for armored cable: used for the armored cable direct entry into explosion-proof

enclosures, they can be built for different types of armors;

- for normal cable: used for the non-armored cable entry into explosion-proof enclosures. The sealing is carried out with a sealing ring directly on the external cable sheath. Each sealing ring is suitable for single cable diameters.

Cable glands must be chosen considering the cable diameter. The tightness is ensured by the compression of a rubber gasket that tightens on the external diameter and prevents the flame from spreading elsewhere. Usually the sealing ring is as long as the lamination joint; some cable glands with a shorter sealing ring can be used in enclosures whose internal volumes are limited by the certificate. Min and max diameters of the use of the cable are reported on the sealing rings. It is forbidden to insert more cables into the same cable gland, as well as to increase the sealing ring diameter with insulating tape or similar, in order to make it match with the sealing ring diameter. Cable glands for armored cables have two sealing rings: the front one tightens on the internal diameter and guarantees the explosion-proof protection; the rear one tightens on the external diameter and prevents liquids from penetrating into the cable gland, where the armor is sealed by two conic rings guaranteeing the electronic continuity of grounding.

There are also “barrier” cable glands. In this case the cable is sealed with a resin in

Image 42 Cooperation among all parts involved



4. Installation

Graph 9 Flowchart to choose the right cable gland

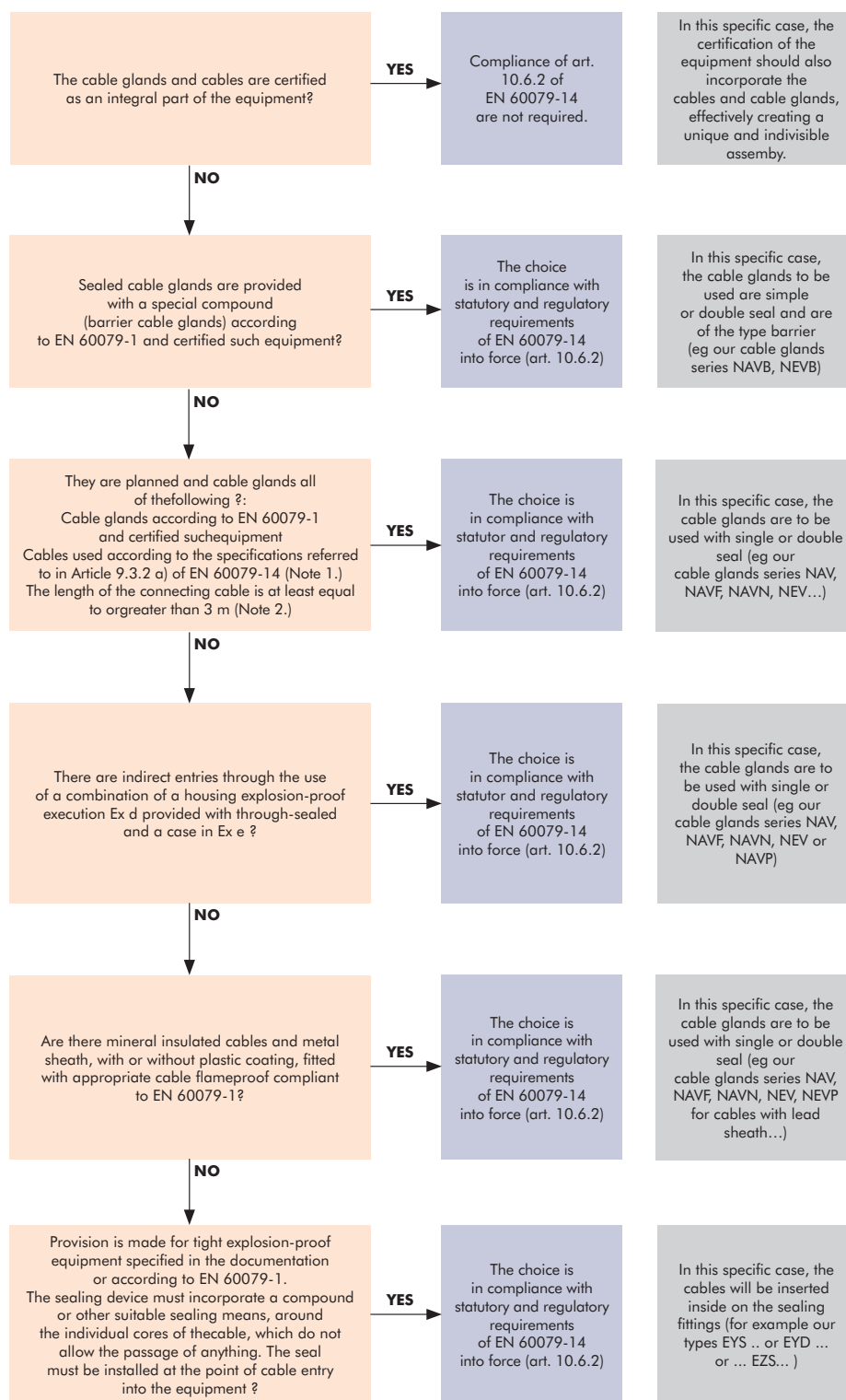

Note 1. With a sheath in thermoplastic material, thermosetting or elastomeric. They must be circular and compact. Any padding or sheathing must be extruded. Any fillers must be non-hygroscopic.

Note 2. The minimum cable length is defined in order to limit the potential danger due to the transmission of flame through the cable. For the test procedures of restricted breathing cable (Appendix E, extracted from EN 60079-14), you have to take a piece of cable with a length of 0.5 m should be tried, once installed in a sealed 5 liters (± 0.2 liters), in conditions of constant temperature. The cable is considered acceptable if the interval of time required to bring down to 0.15 kPa (15 mm of water column) an internal overpressure of 0.3 kPa (30 millimeters of water column) is equal to or greater 5 s.

a sleeve. It is inserted in the cable gland and forms a lamination joint with its internal part of the object. The use of different types of cable glands must follow IEC / EN 60079-14 standards. Depending on the plant type and on the installation, either barrier or cable glands with simple or double sealing rings and related gaskets can be used.

Graph 9 helps you to choose the connection method to explosion proof junction boxes, because it considers all the variables considered by the mentioned standard.

Since we understand that the production of “AD-PE” = explosion-proof safety plants and its maintenance is tough work, considering also entries which need barrier cable glands, we have chosen to provide them with high-safety level equipment, but easier to manage. This is “Ex de” protection method equipment, above mentioned (chapter 3.6.2.5). ■

5. Inspection



What is the aim of inspection? To verify with an inspection that the installation has been properly made, and that it maintains its safety characteristics. We remind you once more that plant inspection and maintenance have to be made by person-

nel trained in the different protection and installation methods, as well as in the national rules about plants and about hazardous areas classification.

The normative standard concerning inspection and maintenance activities is IEC/EN 60079-17.



Graph 10 Types of inspections depending on frequency, quantity and quality parameters

Inspection

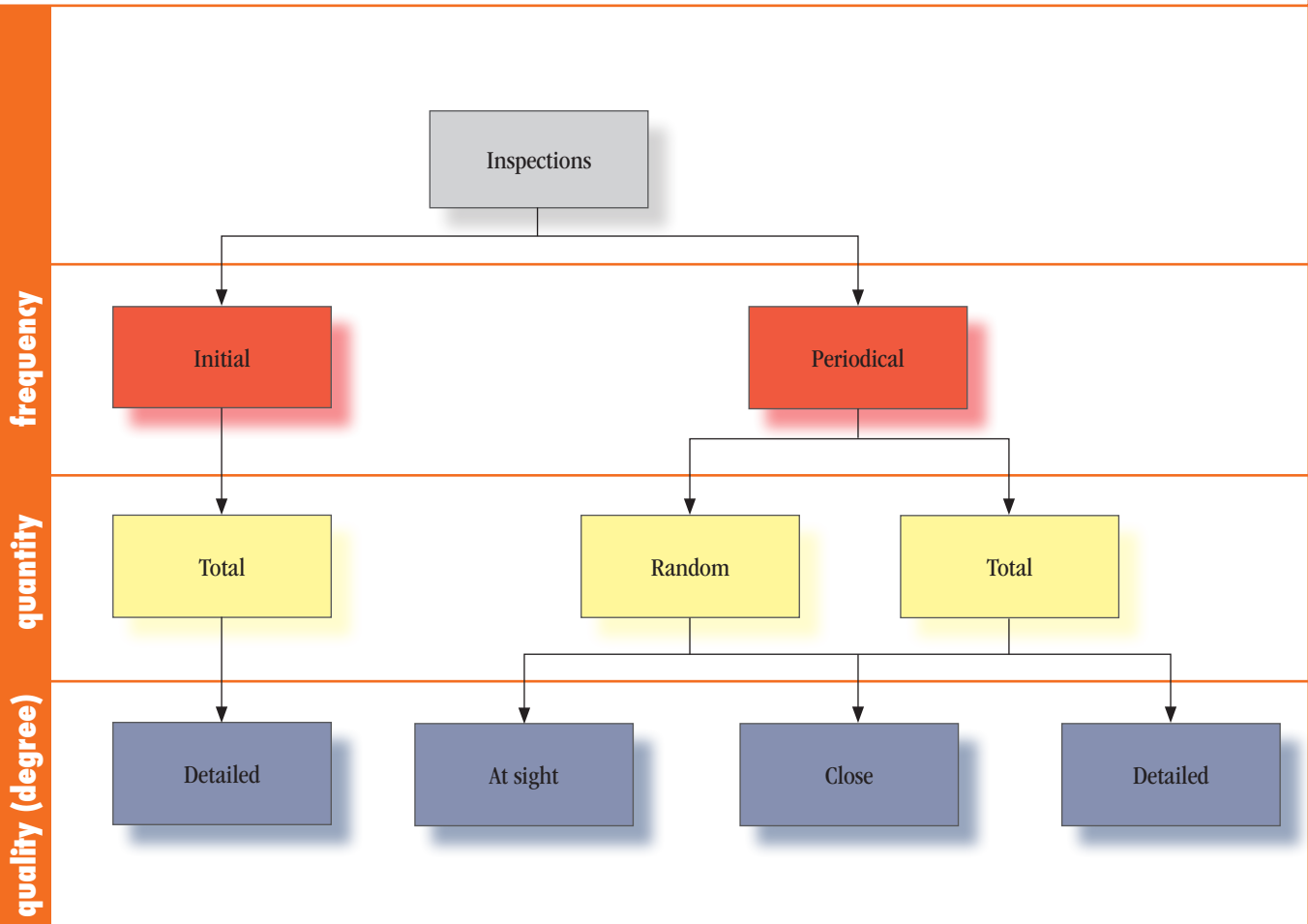

The inspections consider three aspects (Graph 10):

- **temporal:** carried out before the equipment is used (initial) or periodically;
- **quantitative:** made on all equipment (total) or on part of it (random);
- **qualitative:** able to detect defects visible to the naked eye without any extra tool (visual; also able to identify defects detected only with means of access (close); and finally able to detect defects by opening the equipment and/or by using tools (detailed). ■

6. *Maintenance and repairs*



6.1. MAINTENANCE

The maintenance is *“the combination of all the administrative techniques, including the supervisory actions, aimed at maintaining or at bringing an entity into a state where it can perform the required function.”*

Over the years, the approach to maintenance has changed dramatically, passing from

the *“preventive”* one, such as *“maintenance carried out at scheduled intervals or according to defined criteria and aimed at reducing the probability of failure or the degradation of the operation of an entity”*, to the *“accidental”* one, such as *“maintenance after the detection of failure and aimed at bringing an entity in the state where it can perform the function required.”*



The time interval between two maintenance operations depends on different aspects, such as the design choices, the environment where it is installed, the care for the equipment.

Since we handle equipment aiming at reducing the risk of explosion, maintenance should be made punctually, following the instructions carefully.

6.2. REPAIRS

Repairs in general

Repairing is aimed at bringing failed equipment in its suitable operating condition to service in accordance with the appropriate standard. Even though we have forgotten

that high-quality objects can be repaired, this action can be made by specialized centers or by the equipment manufacturer.

Repairing our equipment

We design and make our equipment long-lasting and able to maintain the safety level requested in the hazardous environment where it is installed. Our equipment can be repaired.

In our Italian factory based in Villesse (GO) and in the authorized Cortem centers, our equipment is repaired and restored in accordance with the design documents approved by the Notified Bodies. It can guarantee again the initial safety level. ■

7. *End-of-life equipment*



7.1. DISPOSAL

End-of-life electrical equipment must be disposed of properly. Starting from the title XX “environment” of the Treaty on the Functioning of the European Union, EU has issued a new Directive about waste electrical and



electronic equipment: 2012/19/EU directive of 4th July 2012, according to which some

equipment (like some of ours) has to be disposed of in a certain way. This is why we apply on them the symbol here represented (left below).

Cortem Group, as well as other

companies, in accordance with ISO 14001 standard, has adopted an environmental management system with specific ways to dispose of end-of-life equipment, which is a waste. Each country can have established specific environmental management system concerning waste collection and disposal. Have a look at it for further information.



the packaging and packaging waste. For the packaging of our products we use generally:

- cardboard boxes;
- wooden boxes.
- the second layer is related to the material of the equipment enclosure; our choice is based on both functional and environmental aspects of the product, and we have created the certification of our environmental management system (DNV Certification No. 78704-2010-AE-ITA-SINCERT).

7.2. RECYCLABILITY

Recyclability is strictly connected to disposal. Because of non-endless material availability and of production costs, for several years we have been accustomed to choose materials that can be recycled.

In almost all cases, equipment has three layers:

- the first is related to the packaging, and for its correct disposal EU has issued a Community Directive: 94/92/CE of 20th December 1994 and 2013/2/UE Directive of 7th February 2013, having the change of annex I of 94/2/CE Directive of European Parliament and Board, on

management system (DNV Certification No. 78704-2010-AE-ITA-SINCERT).

Therefore, most of the materials, described in chapter 3, are recyclable:

- aluminium;
- steel;
- polyester, polycarbonate, polyamide;
- glass.
- The third layer is related to the material of the equipment installed inside the equipment enclosure. Even though it is electric equipment, the components are various: wires, terminals, transformers, switches, lamps (filament and discharge, led), electronic circuits, batteries, etc. ■

8. Application examples for different types of plants



8.1. PHARMACEUTICAL INDUSTRIES

Production processes in companies producing drugs for mixing, emulsion and chemical reaction of organic compounds, can generate environmental conditions able to create potentially explosive atmospheres. In the production process, liquid substances are very often used; they can be brought to such tempera-

tures able to emit flammable vapors, or they can reach temperatures even higher than the flashpoint.

Besides industrial plants, where a product process takes place, there are research and development chemical laboratories, in which liquids, gases or combustible dusts could be present in such quantities that they can become a risk of explosion.



Substances are usually contained in sealed enclosures and kept in storage areas, before being produced.

If we quantify the explosion risk, we have to consider the following possibilities:

1. potentially explosive atmosphere due to the production process for the presence of: gases, vapors of flammable liquids processed at temperatures higher than the flashpoint, combustible dusts;
2. potentially explosive atmosphere due to plants serving the production process, such as power plants of gas;
3. potentially explosive atmosphere in chemical plants where studies and researches with flammable substances are carried out (substances such as gases, vapors or mists and combustible dusts), in presence of potential ignition sources.

For areas classification, the first step is to verify the characteristics of all the substances present in the production process, to make a

list and to map the areas where the substances are used or stored. Only highly qualified staff should carry out this activity. Each hazardous substance must have a form indicating all the chemical and physical properties required for the classification (flashpoint, ignition temperature, U.E.L, L.E.L., etc.)

8.1.1. REFERENCE STANDARDS

Hazardous areas classification must be carried out in compliance with EN 60079-10-1 standard for the plant sections with gases, vapors or mists, and in compliance with EN 60079-10-2 standard for the zones with combustible dust. The latter allows the classification considering all the hazards due to the presence of dusts in a cloud and/or of layers of dusts, taking into account the information about the processing.

8.1.2. PLANT EMISSION SOURCES

Let's analyze the plant emission sources of an

industrial pharmaceutical plant.

The emission sources of continuous grade are:

- open enclosures containing the substances in processing;
- enclosures in open air used for the preparation of compounds for hand or automatic mixing and/or in which additions to the processing liquid solution are made.

Depending on the operation procedures, first-degree emission sources are the following:

- loading and unloading in open air;
- pickup points for sampling.

Second-degree emission sources are flanges, unions, valves and, in general, points of discontinuity of the production plant, of containment or conveying.

In presence of combustible dusts in the process (such as lactose, used as adjuvant), the probability that layers are formed as well as the risk that layers rise in clouds becoming emission sources must be verified.

8.1.3. CLASSIFICATION FOR GAS

The result of classification depends on operating conditions, plant parameters, volume of environment, ventilation and coefficient of performance f .

In general, for gases, vapors and mists we could have:

- Zone 0, inside containment systems and inside open enclosures;
- Zone 1, around mixing operations, pickup points, loading, unloading, etc.;
- Zone 2, originated by the emission sources

of points of discontinuity of the plant.

Hazardous areas extension may be determined by “dz” distance, starting from the emission source in direction dependent on the type of gas.

8.1.4. CLASSIFICATION FOR DUSTS

In presence of dust in the process, we could have:

- Zone 20, inside containment systems, loading hoppers, etc.;
- Zone 21, originated by the emission sources due to loading and unloading operations, etc.;
- Zone 22, originated by points of discontinuity of containment systems, by the sealed inlets and possibly around Zone 21.

8.2. DEPOSIT OF CEREALS

Cereal storage silos are deposits, inside or outside a building, where food industry products (such as wheat, grain, rice, or similar – Tab. 28) are stored. Loading operations are performed by means of mechanical devices such as tubes, conveyor belts, augers etc., through inlets placed on the top of the tower silo. Once disconnected, products are picked up by unloading doors placed on the lower part, or transported through pneumatic conveying systems or manually.

All food products are made of coal, hydrogen, nitrogen, sulfur, oxygen, etc. Therefore, they are combustible and may provoke fires and explosions. If cereals are ground before being stored, they can have an extra-thin consi-



stency and, if particle size is lower than 500 μm , particles themselves can originate an explosive atmosphere if mixed with air.

In any case, even if cereals have higher sizes, we have to consider that solid parts usually generate dusts. The rule says that dusts generate thinner and thinner dusts.

Presence of combustible dust always generates risk of explosion, if triggered.

8.2.1. RISK OF EXPLOSION BY CLOUDS OF DUST

Air is always present inside the silos, and stored cereals form deposited layers of dust. During loading and unloading operations,

the layers, due to air circulation, generate a continuous cloud.

Airborne combustible dusts form clouds of explosive atmosphere. Clouds, if triggered, can oxidize so rapidly that they can generate an explosion. The greater the reactivity of dust is, the smaller its particles are.

Cloud is explosive when the concentration of dust inside substance explosion ground ranges between L.E.L (Lower Explosive Limit) and U.E.L. (Upper Explosive Limit), expressed in dust grams per air volume, g/m^3 .

8.2.2. AREAS CLASSIFICATION

Hazardous areas classification in a silo can be made according to EN 60079-10-2 standard, that allows classification considering the hazards due to the presence of dusts in a cloud or of layers of dust.

8.2.3. AREAS INSIDE CONTAINMENT SYSTEM

Inside silo volume, the layer of stored cereals is continuous-degree emission source and may generate a Zone 20 extended to all the internal silo volume.

If loading and unloading operations are carried out through automatic conveying systems, a dust/air mixture is formed and it may generate a risk of explosion. In this case, the interior of the transport system is classified as Zone 20.

8.2.4. AREAS OUTSIDE CONTAINMENT SYSTEM

During loading and unloading operations, a certain quantity of dust is emitted through

8. Application examples for different types of plants

the inlets connected with the outside. In case of frequent or continuous operations, inlets and outfalls are to be considered first-degree emission sources, they may originate a Zone 21 and, possibly, a Zone 22 all around.

Open systems of automatic transport, such as conveyor belts, open bucket elevators, can be considered first-degree emission sources, and they may generate a Zone 21 and, possibly, a Zone 22 all around.

8.2.5. ELECTRICAL INSTALLATIONS

Possible electrical installations controlling loading / unloading equipment, must be manufactured and certified in order to be used in areas with presence of explosive atmosphere. As far as electrical equipment classification is concerned, please refer to Tab. 27 indicating the ATEX markings that must be present in each Zone.

Tab. 27 ATEX markings that must be present in each Zone

ZONE	MARKING
ZONE 20	CE Ex II 1D
ZONE 21	CE Ex II 2D
ZONE 22	CE Ex II 3D

8.3. COATING BOOTHS

The coating booths where spray coating is used, are areas with risk of explosion. Spray coating is based on the forced passage of flammable liquid or of dust coatings through the gun nozzle.

8.3.1. COATING BOOTHS WITH LIQUID COATINGS

The protection methods to use in order to prevent risks of explosion in the coating bo-

Tab. 28 Some examples of dusts and their characteristics

Substance	Particles medium dimensions [μm]	L.E.L [g/m^3]	Cloud ignition temperature T_d [$^{\circ}\text{C}$]	Layer ignition temperature 5mm $T_{5\text{mm}}$	Dust conductivity (C/NC)
Wheat flour	57	40	440	325	NC
Grain	80	60	370	370	NC
Soybean flour	59	125	430	430	NC



booths with liquid coatings are contained in the UNI EN 12215 standard “*Coating booths for the application of liquid coating products – Safety requirements*”.

According to this standard, the concentration of flammable substances must be kept below L.E.L. (Lower Explosive Limit) by means of forced ventilation. In particular, the standard contemplates two possibilities:

1. Concentration within 25% of L.E.L. (booths with the presence of an operator). In this case, the internal volume of the booth (ducts for air recirculation included) as well as the external one, up to 1m from the permanent openings, are classified as Zone 2.
2. Concentration within 50% of L.E.L. (booths without the presence of an operator). In this case, the booth must be provided with a control system of the L.E.L. able to stop the influx of flammable substances when 50% of

L.E.L is reached. The internal volume of booth (ducts for air recirculation included) is classified as Zone 1, while the external one, up to 1m from the permanent openings, is classified as Zone 2.

8.3.2. COATING BOOTHS WITH DUST COATINGS

Protection against risks of explosion in coating booths with dust coatings is regulated by the UNI EN 12981 standard “*Coating booths for the application of dust coating products – Safety requirements*”.

According to this standard, the concentration of flammable substances must be kept below 50% of the dust L.E.L., by means of forced ventilation; if L.E.L. value is not reliable, medium concentration must not exceed 10 g/m³. The following classification is foreseen:

- Zone 22: internal volume of booth (ducts for air recirculation as well as the open dust col-

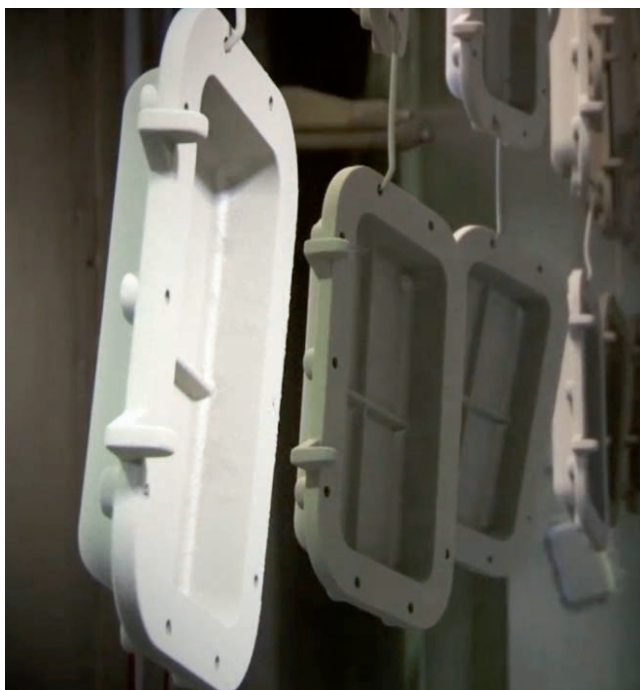

8. Application examples for different types of plants

lection systems included);

- Zone 22: external volume of booth, up to 1m from the permanent openings;
- Zone 20: sealed dust collection systems.

Dust characteristics vary and depend on the product used. Usually, L.E.L. ranges between $10 \div 100 \text{g/m}^3$, while ignition temperatures vary between $350 \div 400^\circ\text{C}$ (cloud) and $200 \div 250^\circ\text{C}$ (layer). Information stated in the product safety form must be verified.

8.4. BIOGAS PLANTS

In the modern biogas plants, biodegradable organic substrates such as grass, straw, manure, biodegradable waste, residues of food production, leftovers and greases are fermented. For this purpose fermenters, that are sealed containers, are filled with organic materials. In this environment without oxygen, bacteria produce biogas starting from orga-

nic compounds in fermentation. Such biogas is used for the production of electrical energy and heat.

8.4.1. PLANT TYPE

These biogas plants (Image 43) are composed of a primary mixing tank, possibly of a sanitation tank, of a main heated fermenter, a final storage tank and, sometimes, of a secondary fermenter.

Once the biogas is produced, it must be processed and stored before being reused.

The co-generator is composed of a gas engine with heat exchanger and generator. On the basis of the energy content of biogas, this produces electrical energy with a 30% efficiency and heat with a 60% efficiency. The electrical energy is fed into the network. The heat is used for the fermenters, and the excess heat for houses, agricultural structures or similar.

Image 43 Biogas plant scheme

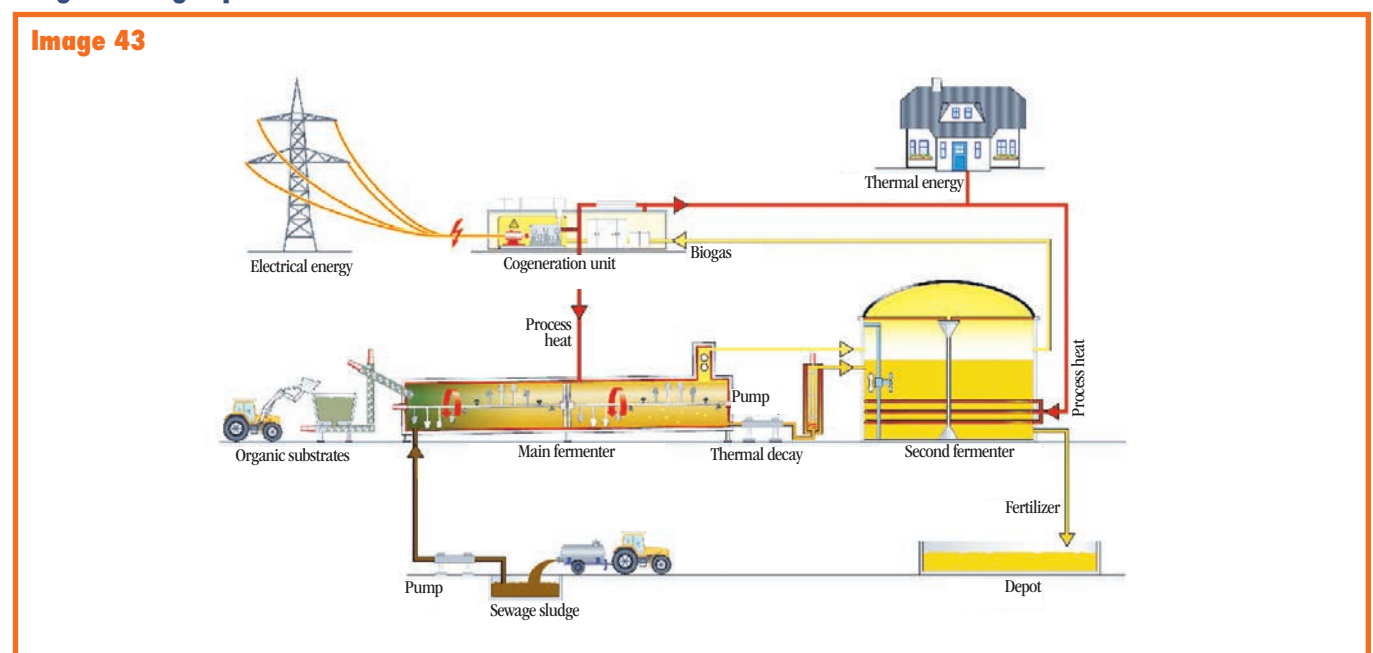



8.4.2. RISK OF EXPLOSION

Since in a biogas plant there is always the presence of explosive atmosphere, especially in the gas tank area and in the fermenters, these plants are to be considered at risk of explosion.

Currently ATEX 2014/34/UE and ATEX 1999/92/CE are the reference directives for equipment and protection systems meant to be used in explosive atmosphere.

Their reference standard is EN UNI 1127-1 “*Explosive atmospheres – Explosion prevention and protection – Part 1: Main concepts and methods*”, where 13 different ignition sources are listed.

It is a general protection standard that considers each possible ignition source and, in particular, protection from lightning. All of these plants are isolated in the countryside and, therefore, are exposed to lightning risks.

8.4.3. REGULATIONS

The employer must survey and evaluate all risk factors for the areas with risk of explosion. Environments with explosive atmosphere must be subdivided into areas, following the EN 60079-10-1 standard for gases and EN 60079-10-2 standard for dusts.

Depending on the results of risk assessment, the areas with risk of explosion must be defined and described in a document for the protection against the risk of explosion. In case of protection against lightning, the series CEI EN 62305 standards must be followed.

All the electrical equipment placed in classified areas must comply with safety requirements and belong to the protection degree suitable to the type of classified area, according to the ATEX 2014/34/UE standard. ■

9. Appendix

9.1. BRIEF DESCRIPTION OF PROTECTION METHODS FOR ELECTRICAL EQUIPMENT ADDRESSED TO AREAS WITH RISK OF EXPLOSION FOR PRESENCE OF GAS (TAB. 29)

Tab. 29 Gas protection modes

Protection mode	IEC/EN standard	Base principle	Main characteristics	Applications
“d” explosion-proof enclosures	IEC 60079-1 EN 60079-1	Containment	Gas may enter. If triggered, the atmosphere explodes. Enclosure contains explosion and joints are designed so that flame cools while going out, and only the combustion product, unable to trigger the surrounding atmosphere, arrives outside.	Control panels, lighting fixtures, switches, control unit. All the equipment that, in normal operating conditions, can provoke sparks or over temperatures.
“e” increased safety	IEC 60079-7 EN 60079-7	Prevention	Building requirements preventing arcs, sparks or high temperatures, such as isolation distances in air and enlarged surfaces.	Non-sparking equipment such as: enclosures, terminals, lighting equipment, revolving machines.
“i” intrinsic safety	IEC 60079-11 EN 60079-11	Prevention	Electrical equipment installed in hazardous area is part of a system of circuits and electronic barrier limiting its performance at such energies that the ignition of explosive atmosphere is prevented by the control of electrical parameters (power, current, inductances and cable grounding capacity, etc.). Intrinsic safety protection mode is achieved with an equipment inside the area, a connection circuit and a barrier, generally installed outside hazardous area.	Electrical parameter limitations exclude the application to power equipment. It is applied to measure and control machinery as well as to regulate the production processes.
“n” protection mode	IEC 60079-15 EN 60079-15	Prevention	Protection mode made according to building prescriptions and less strict values in order to prevent the ignition of explosive atmosphere only in normal equipment functioning. Ex nC= protected contacts Ex nR= limited respiration	Lighting equipment, control panels, control stations for Zone 2.
“p” internal overpressure	IEC 60079-2 EN 60079-2	Segregation	Live equipment and circuits enclosed in an enclosure, in which pressure is kept higher than the outer one by the insertion of an inert gas or air. In this way, the ingress of explosive atmosphere is prevented. It requires sophisticated control and alarm systems.	It is suitable to carry out complete controls because of the lack of a construction dimensional limit as well as of electrical measurements of the equipment it contains.
immersion in oil “o”	IEC 60079-6 EN 60079-6	Segregation	Electrical equipment is fully immersed in oil so that explosive atmosphere, that is outside or above the liquid, cannot be triggered.	It is applied above all to devices not provided with moving parts.
“q” powdery filling	IEC 60079-5 EN 60079-5	Segregation	Enclosure containing electrical equipment is filled with dust (for example, quartz powder) that prevents the ignition of external explosive atmosphere.	It is applied to small components such as capacitors, transformers, or electronic devices such as starters for tubular lamps.
Encapsulation “m”	IEC 60079-18 EN 60079-18	Segregation	Components which may cause sparks or over temperatures are fully covered with a compound (usually resin), in order to separate them from explosive atmosphere. Compound resists to ambient conditions in which the equipment operates and it is tested to guarantee the maintenance of its properties in the time (aging).	Small sized equipment such as capacitors, reactors, transformers, level and proximity sensors and electronic equipment in general.

9.2. BRIEF DESCRIPTION OF PROTECTION METHODS FOR ELECTRICAL EQUIPMENT ADDRESSED TO AREAS WITH RISK OF EXPLOSION FOR PRESENCE OF DUSTS (TAB. 30)

Tab. 30 Protection methods – Dusts

Protection mode	IEC/EN standard	Main characteristics	Applications
Absence of ignition source. Protection with “t” enclosures (ta, tb, tc)	IEC 60079-31 EN 60079-31	Enclosure sealing prevents the ingress of dust or reduces it to a minimum non dangerous quantity. In this way equipment can be mounted inside the enclosure. Enclosure surface temperature must not trigger the surrounding atmosphere.	Control panels, lighting fixtures, engines, connection enclosures and terminal strips.
Absence of ignition source. “i” intrinsic safety protection (ia, ib, ic)	IEC 60079-11 EN 60079-11	Equipment used in a potentially explosive area containing only intrinsic safety electrical circuits. Each electrical circuit is intrinsically safe when any spark or thermal effect produced in conditions such as normal functioning and specific failure conditions are not able to cause a combustion of an explosive atmosphere.	Sensors, actuators, measure and control technology.
Absence of explosive atmosphere. “p” pressurization	IEC 60079-2 EN 60079-2	The “Ex p” internal overpressure protection mode consists in injecting protection gas in the enclosure to keep it in overpressure comparing to external atmosphere, preventing the creation of explosive atmosphere inside the enclosure. Protection gas can consist in air or inert gas, such as nitrogen.	MT/BT transformers, big electrical machinery, (alternative to “Ex e” protection), automation and instrumentation panels, industrial processes control systems (gas chromatographs, analyzers), analysis cabin and pressurized cabins.
Ignition source segregation. “m” encapsulation (ma, mb, mc).	IEC 60079-18 EN 60079-18	Components that may produce sparks or overpressures are fully covered with a compound (generally resin), in order to separate them from explosive atmosphere. Compound resists to ambient conditions in which the equipment operates and it is tested to guarantee the maintenance of its properties in the time (aging).	Small-sized equipment such as capacitors, reactors, transformers, level and proximity sensors and electronic equipment in general.

9.3. BRIEF DESCRIPTION OF PROTECTION METHODS FOR NON-ELECTRICAL EQUIPMENT ADDRESSED TO AREAS WITH RISK OF EXPLOSION FOR PRESENCE OF GAS AND DUSTS (TAB. 31)

Tab. 31 Protection methods for non-electrical equipment in presence of gas and dusts

Protection mode	ISO/EN standard	Main characteristics	Applications
Absence of ignition source. “h” constructive safety	ISO 80079-37	Technical principles tested on equipment with no ignition source in normal operations are applied. The risk of mechanical breaks, that can cause flammable temperatures and sparks, is therefore reduced to minimum.	Joints, pumps, gears, transmission chains, conveyor belts.
“k” ignition source control	ISO 80079-37	Sensors inside the equipment survey possible risks of explosion in the initial phase, so that countermeasures can be applied before potential ignition sources become effective. The measures applied can be started automatically by a direct connection between sensors and ignition protection system, or manually by sending an information message to the operator.	Pumps, conveyor belts.
Ignition source segmentation. Immersion in liquid “h”	ISO 80079-37	Ignition sources become inactive by being immersed in a protective liquid or by being constantly kept humidified with a liquid film.	Submergible pumps, gears, immersion in liquid.

***Marking
of electrical equipment in areas
at risk of explosion***

Marking of electrical equipment in areas at risk of explosion

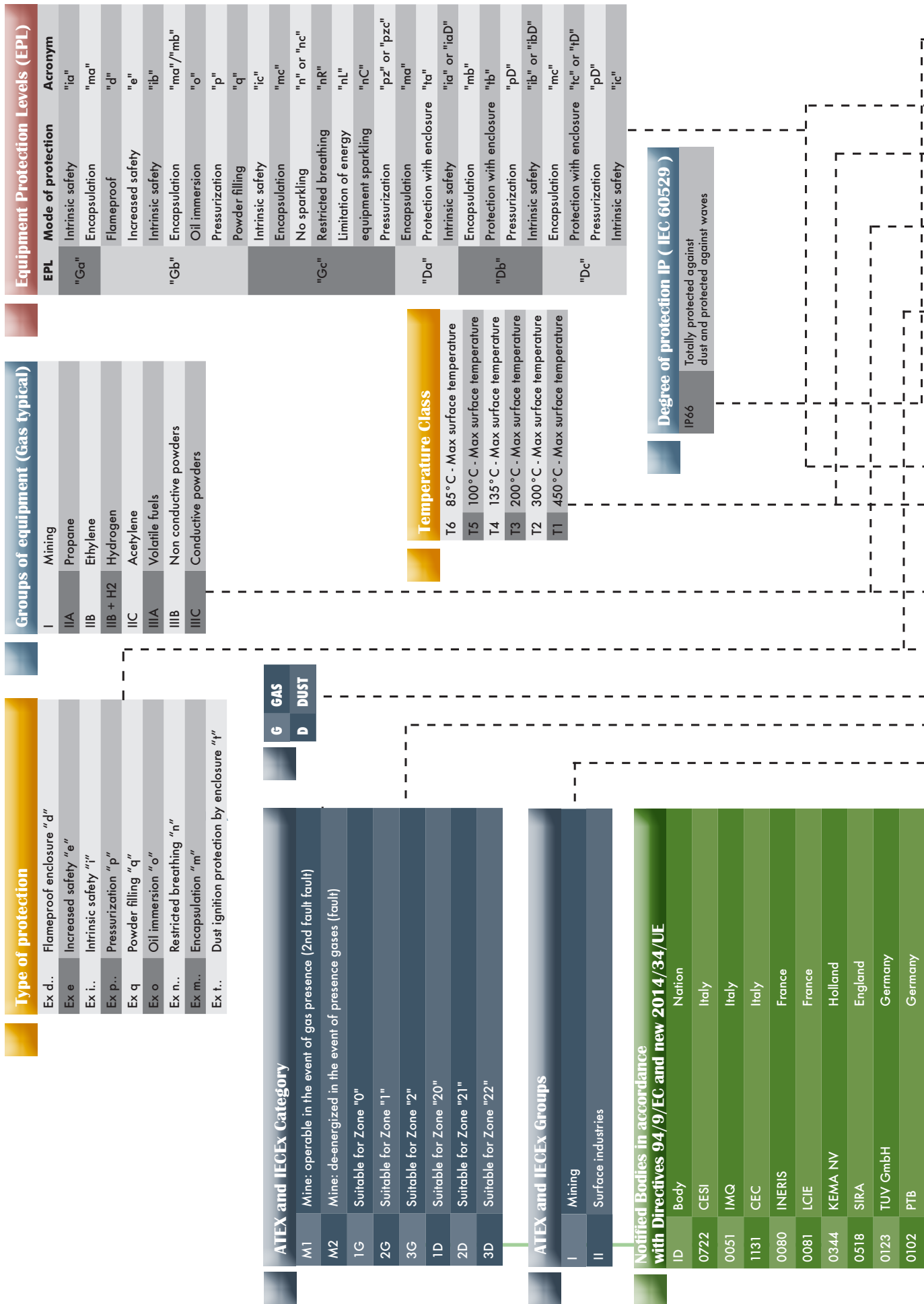

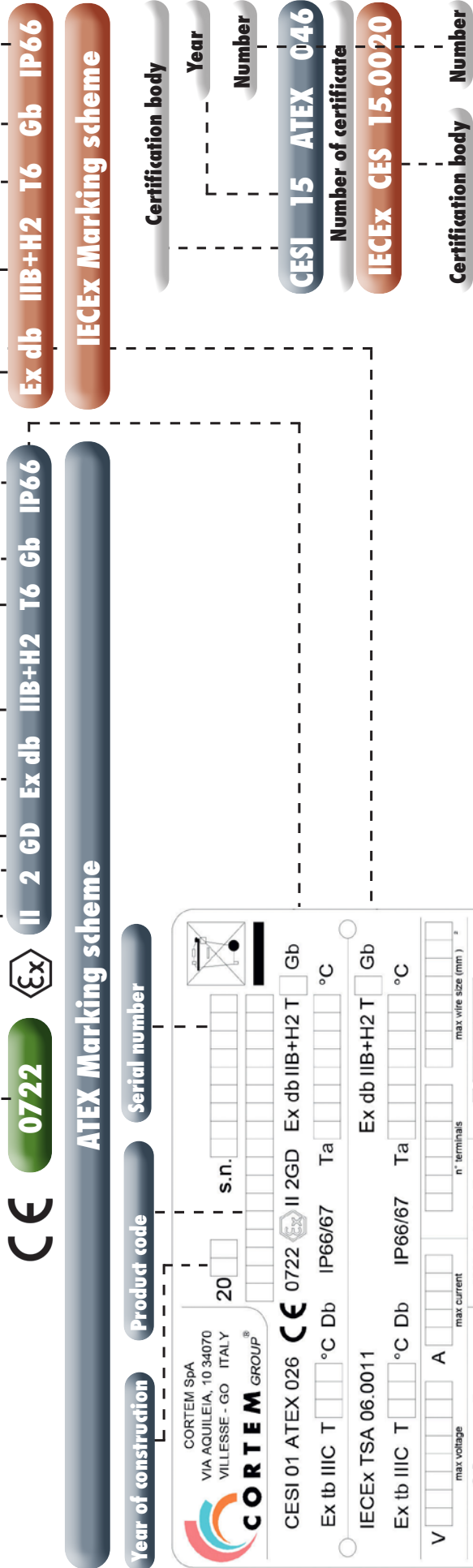

Year of construction Product code Serial number

ATEX Marking scheme

IECEX Marking scheme

Certification body

Year

Number

CESI 15 ATEX 046

Number of certificate

IECEX CES 15.0020

Certification body Number

CORTEM GROUP
To be sure to be safe



Since 1968, Cortem S.p.A. has been designing and manufacturing explosion-protected electrical equipment addressed to hazardous areas (with risk of explosion and fire).

Thanks to a continuous effort in technical innovation and improvement, it is today a leader in this field, able to provide a whole range of products, meeting on-shore and off-shore applications.

The peculiarity of Cortem Group, formed by the brands Cortem, Elfit and Fondisonzo, is the experience gained in more than 40 years of activity in the field which results not only in the supply of simple Ex-products, but also in customized solutions.

All our products are internally designed and manufactured following different protection methods, such as "Ex d" explosion-proof, "Ex e" increased safety, "Ex de" mixed, "Ex n" non-sparkling, and using aluminium alloys, tited steels and first-quality plastic materials that assure resistance and duration. Aluminium alloy used by Cortem has passed all tests required by EN 60068-2-30 Standard (hot/humid cycles) and EN 60068-2-11 Standard (salt spray test). All our products in aluminium alloy are protected by an epoxy coating RAL 7035. This treatment, only provided by Cortem Group, guarantees a durable protection.

Cortem production range can be summarized as follows:

- Lighting fixtures, obstruction lighting fixtures, floodlights and hand lamps.
- Junction and pulling boxes, control stations.
- Signaling and control equipment, plugs and sockets.
- Cable glands and electrical fittings.
- Special executions: switchgears and panel boards tailor made upon customers specifications.

90% of our production are located in the Oil & Gas sector both off-shore and on-shore, but also in chemical, pharmaceutical plants and in all those manufacturing areas where the presence of explosive atmospheres may occur such as grain silos, woodworks and paper mills. We invest every year some of our resources to develop innovative products that meet the market needs and, for this reason, our R&D department studies the best solution valuating normative and market price issues, plant and security aspects.

With more than 30 agencies, 90 distributors, 7 partners and 3 production centers displaced, Cortem provides a local and qualified presence around the world. For Cortem "displacing" does not means transferring facilities, resources and know-how in low cost Countries, but replicating a successful model of industrial organization in which environment safety, product quality, compliance with standards, technical and after-sales services are the fundamentals of our corporate mission.

The pay-off "to be sure to be safe" represents our pride and passion for what we design and manufacture.

Guide to the Ex world

How to use the electrical equipment in areas with risk of explosion

Issued February 2022

Copyright

In accordance with copyright laws, the Italian Civil Code and other regulations in effect in the markets where the Cortem Group operates, all the information, images, photographs, drawings, tables and anything else contained in the Cortem Group promotional material are the exclusive property of the Cortem Group, which has all the moral rights to the aforesaid material as well as the right to use it for commercial and economic purposes. It is therefore forbidden to reproduce all or part of the Cortem Group promotional material in any way, unless otherwise authorized by the Cortem Group in writing. Any violation of the above is against the law. © by Cortem - Villesse - Italy. All rights reserved.



Sales Offices

Piazzale Dateo 2
20129 Milan (ITALY)
Ph. +39 02 76 1103 29 a.m.
Fax +39 02 73 83 402
infomilano@cortemgroup.com

Export

Ph. +39 02 76 1105 01 a.m.
Fax +39 02 73 83 402
export@cortemgroup.com
saleseurope@cortemgroup.com

Headquarters and Factory

Via Aquileia 10
34070 Villesse (GO), Italy
Ph. +39 481 964911 a.m.
Fax +39 0481 964999
info@cortemgroup.com



Headquarters and Factory

Via Aquileia 10
34070 Villesse (GO), Italy
Ph. +39 481 964911 a.m.
Fax +39 0481 964999
info@elfit.com
vendite@elfit.com
www.elfit.com



Sales Offices

Piazzale Dateo 2
20129 Milan (ITALY)
Ph. +39 02 76 1103 29 a.m.
Fax +39 02 73 83 402
infomilano@cortemgroup.com

Export

Ph. +39 02 76 1105 01 a.m.
Fax +39 02 73 83 402
export@cortemgroup.com
saleseurope@cortemgroup.com

Headquarters and Factory

Via Aquileia 10
34070 Villesse (GO), Italy
Ph. +39 481 964911 a.m.
Fax +39 0481 964999
info@cortemgroup.com



To be sure to be safe.

www.cortemgroup.com